



**SLIDERS** page 01



**SHOWERS** page 36



**HANDRAILS** page 42



**GATES** page 50



**MIRROR** page 52



**TABLETOPS** page 54



**CUSTOM GLASS** page 56



**SANDBLAST** page 58



**LAMINATED** page 60



**SPANDREL** page 66



**GLASS SELECTION** page 68



**COLOR GLASS** page 70



**CURTAIN WALL** page 72



**STOREFRONTS** page 74



**FULL FRAME** page 80



**ALL GLASS DOORS** page 84





As one of the largest glass and metal suppliers in the nation, PRL's goal is to provide our customers with the most complete line of glass entry systems available, thus offering the convenience and benefits of buying from a single source supplier. To that end, we continue to develop and improve our product lines. One of our more recently developed products, our Accordion Aluminum Bi-Fold Door line, is earning its place as one of our top performing products thus far!

The demand for "Accordion" doors is increasing daily. We invite you to join in this growing "Indoor/Outdoor Living" sliding door market! Our Bi-Fold system provides superb sound control, excellent air and water protection, ease in operation and is hurricane impact rated. Added to this outstanding product is the advantage of production times that are the fastest in the industry! Please visit our website or contact our knowledgeable staff for more information.

PLEASE NOTE: PRL continuously improve products design and performance, we reserve the right to make changes without notice.



# Accordion Bifold

Performance,  
Safety & Sound  
Reduction Glazing  
Options

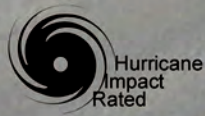

12 ft Tall

90 degree  
angular  
Accordion  
Bifold System.

(800) 433-7044

www.prlglass.com



# Accordion Bifold

- Versatile
- In-line / Multiple Panels
- Custom Configurations
- Weather Resistant
- Thermally Broken
- Dual Tone Finish feature





### Specifications

**In a single direction:**

- Maximum Panel Weight -220 lbs each panel
- Minimum Panel Width -24"
- Maximum Panel Width - 42"
- Maximum Panel Height -120"
- Door Thickness - 2 1/2"
- Maximum # of Doors: 8 each way = 16 panels = 45 ft total.

**Extrusions:** Aluminum 6063-T5.

**Finishes:**

- Clear and Bronze anodized finishes Class 1 .
- Standard Mill Finish available for custom colors.
- Powder Coat : White
- Custom finishes available: Wood Grain finishes available

**Hardware:** Stainless Steel Components .

**Lever Lock Sets:** A Set- 316 Stainless Steel, B Set- Powder Coat over Brass.

**Multi-point Door Locks:** Faceplate, latch and hooks



Custom Bi-Fold with Reflective Glass



### Configurations:

- 2L
- 3L1R
- 2L2R
- 3L3R
- Custom
- 1L2R
- 4L
- 4L1R
- 8R



NOTE: When using maximum panel width & height 42" x 120" panel may exceed maximum panel weight of 220 lbs, consult PRL for details. Panel heights of 120" and over may fall under the weight restrictions.



### Standard Features

Accordion Bi-Fold doors satisfy a wide spectrum of design and functionality requirements. Accordion are flexible, offered as a top hung system with a floor guide and provide reliable weather protection with an innovative seal system.

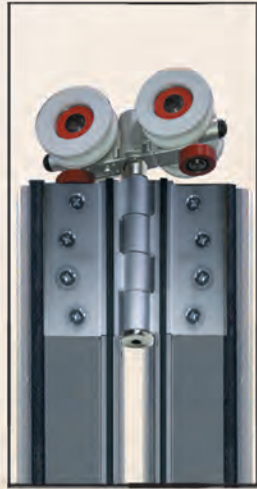

- 2"H x 4 3/4"W Head Track

- Top Hung Roller

- 3 1/2"H x 2 1/2"W Top Thermal Break & Single Glass Stop Rails

- Integral Weather Seal Interlock System

- High Performance 1" IG Glazing

- Perimeter Weatherstripping

- 10"H x 2 1/2"W Bottom Thermal Break & Single Glass Stop Rails (Also Available 3 1/2"H)

- 3 1/2"H x 2 1/2"W Vertical Thermal Break/Single Glass Stop Stiles

- PRL Hinge unibody design/ integral weatherstripping

- Sill / Bottom Track 1/2"H x 5 7/8"W ADA Sill

Also Available:

- 1 3/16"H x 4 3/4"W High Sill
- 13/16"H x 6 1/4"W Low Sill.

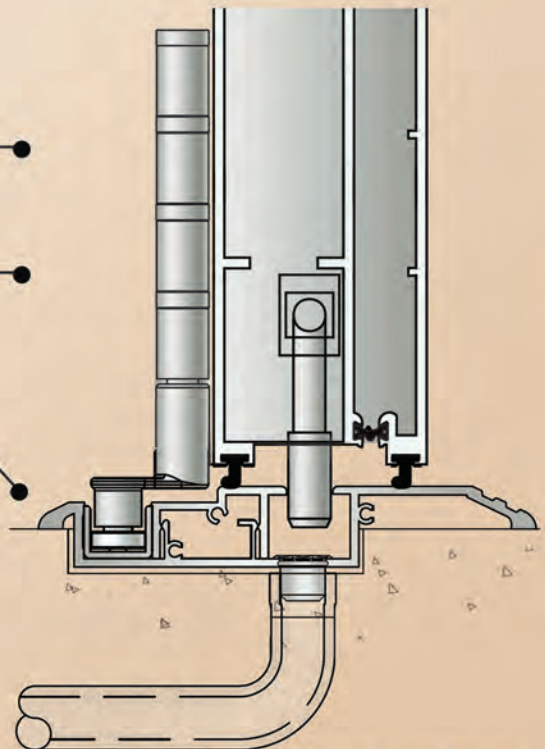
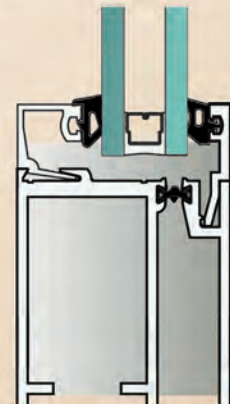
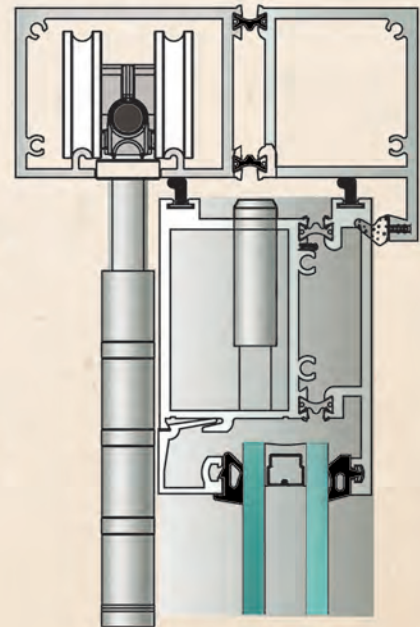





Performance & Safety Glazing Options

Multi-point Door Lock:

- Up to three Lock Point deadbolt
- Deadbolt, upward/downward shootbolt
- Lever Lock Set/Contemporary Handle Style



Bi-fold Sandblast Border Design



Glass Unlimited Options

- IG Units
- Low E
- Reflective
- Dual/triple Insulating
- Laminated
- Sandblast
- Texture

Custom Features:

- Custom Design Bi-Fold System
- All stainless steel top hung hardware/mortise hinge system
- Designed for durability
- Surface hinge option provides a simple operation
- Superior rigidity and performance
- Concealed locking
- Three point Perimetral seals

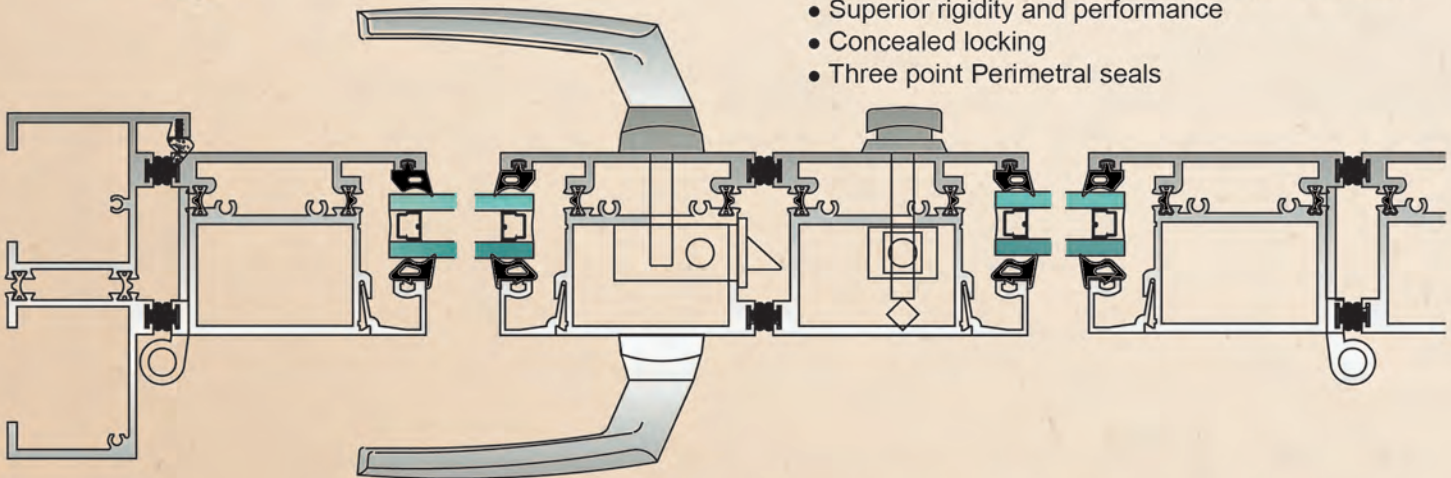

Frame & Door Panel Finishes:

- White Powder Coat
- Anodized Clear, & Bronze
- Dual tone available



Clear Anodized



Bronze Anodized



Custom Graphic Wood Grain Coat



White Powder Coat & Custom Colors



**Tiffany Glass Sliding System**

PRL's Tiffany Interior Sliding System is another of our top performing products. A top hung sliding unit, our Tiffany doors slide effortlessly using only two small suspension points. The heavy-duty, narrow track is the perfect solution for limited head space. This system is the ideal solution for a cost effective sliding door that will add elegance to any room!



Bathroom Slider System with Petite S System

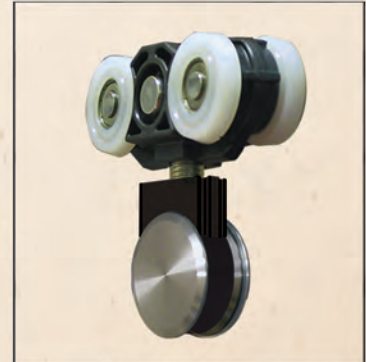

**Petite R**  
1" Round



**Petite S**  
1" Square

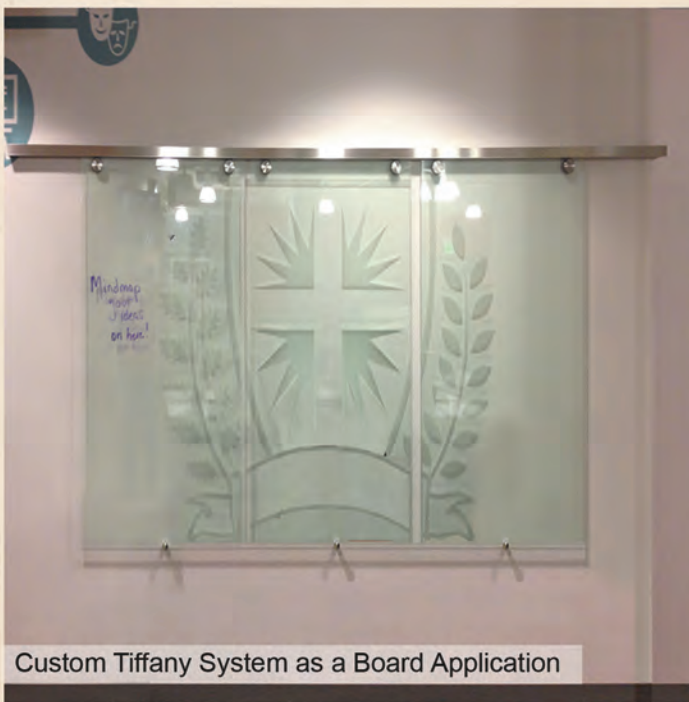

Custom Tiffany System as a Board Application



Residential Slider with R Rollers





Office Tiffany Slider System Double Doors with Custom Sandblast Design & Square Locking Ladder Pulls





Multiple Doors Tiffany Slider with Locking Ladder Pulls, Custom Sandblast & Gluechip Border





Custom Office Glass Wall with Tiffany Slider System

Tiffany sliding system is hung with a minimal top track (ceiling or wall mount) creating a floating effect . This application enhances the appearance of a room by reducing the barrier between areas making a room appear larger, open, and spacious.

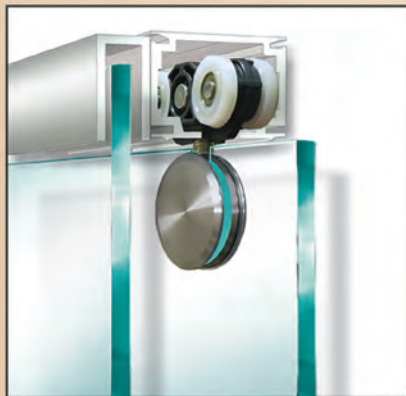

Top Hung Slider Door/Sidelite  
2 3/8" DIA Roller

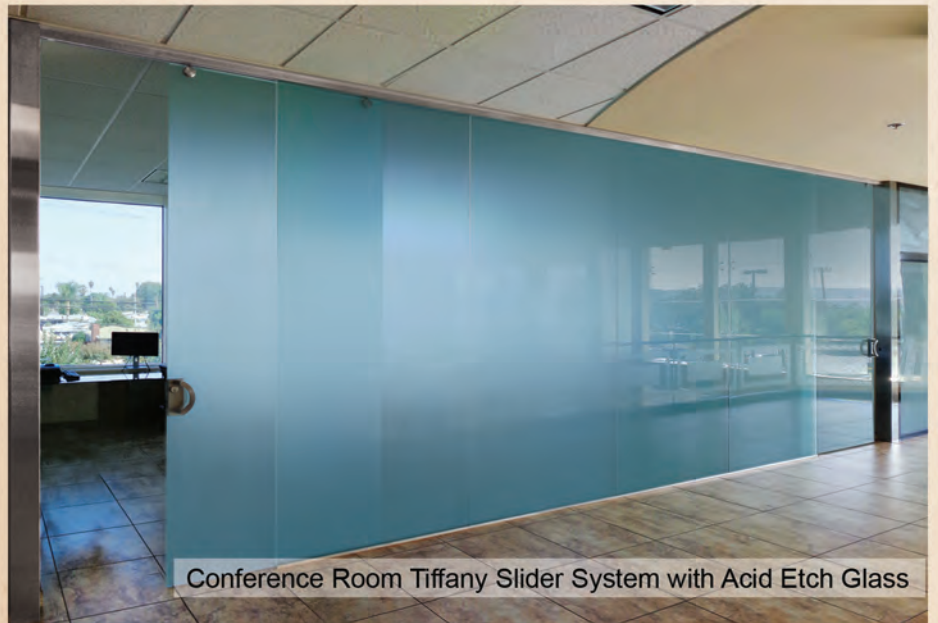

Conference Room Tiffany Slider System with Acid Etch Glass





Residential Tiffany System with Spandrel Glass



Tiffany with Center Locking Housing & Custom Handle



Tiffany All Glass Slider with Custom Pull



Office Slider Doors System with Short Ladder Pulls





Residential Wall Mount Tiffany Sliding System

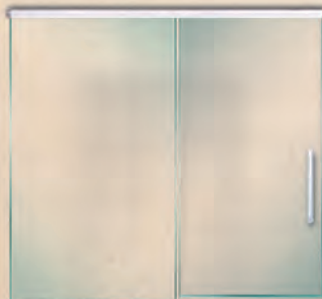

Top Hung  
Head Mount



Top Hung  
Side Wall Mount

**Configurations**

- Single Pocket
  - Hidden Pocket or
  - Lateral Surface mount
- Door/Fixed Panel

**Mounting Options**

- Top Hung
  - Concealed/Exposed
- Lateral
  - Surface Mounts

**Weight & Size Limits**

- (2) Rollers 265 lbs
- (3) Rollers 353 lbs
- Max Panel Width 50"
- Max Panel Height 108"

**Glass Thicknesses**

- 3/8" and 1/2"

**Available Finish**

- 4 Brushed SS
- Polished SS

**Hardware**

- Flush Mount Finger Pull  
Lock when Requested
- Concealed Door Stop
- Floor Guide  
Surface mount



**PL-SHTBS**  
TOP TRACK 2-3/16" X 1-5/8"

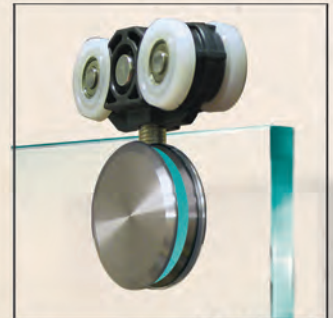

**PL-RSCBS**  
ROUND SLIDING ROLLER 2 3/8" DIA



**PL-GGLBS**  
LOCK/STRIKE 1 7/8"DIA

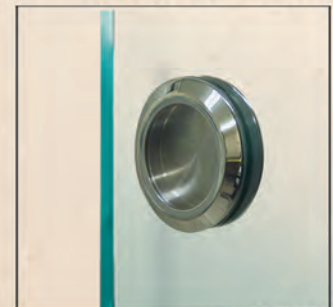

**PL-SHBS**  
FINGER PULL 2 1/4"DIA



**PL-TDGBS**  
GUIDE FITTING 4 1/2"H / 2 1/4" W



**Top Hung Ruby Slider System**

PRL's Ruby Interior Sliding System is a contemporary top hung stainless steel sliding door system that offers a smooth and easy operation. This frameless glass system can be used with single or double doors for residential applications, or customized to suit other applications.

Our Ruby slider uses compact exposed components with surface flush mount fasteners that provide a unique, edgy look. The support tube is secured with offset mount brackets on glass and with adaptors can be wall mounted. Compact heavy duty track supports reduce the gaps between glass surfaces panels. The frameless transparency of this system creates visually roomier spaces while providing a means for privacy.



Ruby Glass Mount Slider System

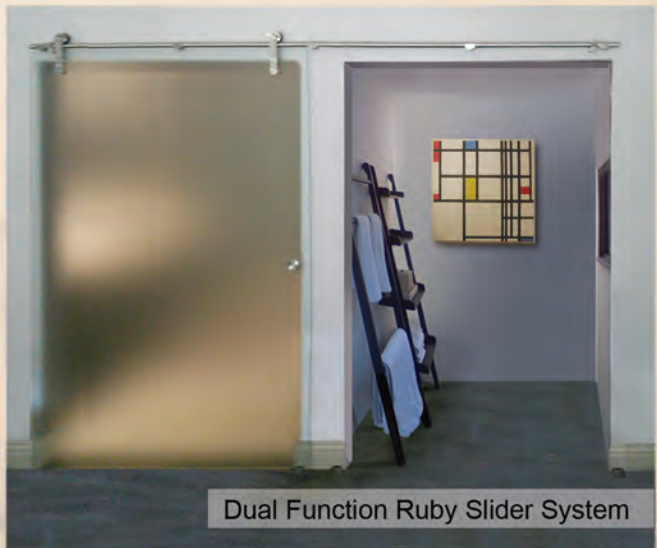

Dual Function Ruby Slider System



By Pass Ruby Slider System

- Hanger/roller system
- Frameless panel
- In-line
- Single/Multiple Panels

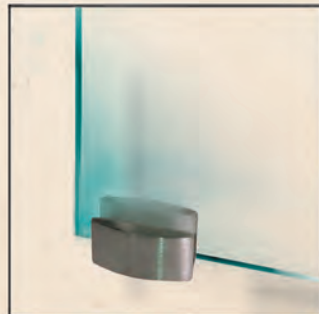

**PL-RMFG**  
FLOOR MOUNT GUIDE  
1 3/8" H / 2" L



**PL-TPS**  
BAR WALL MOUNT BRACKET  
1 3/4" DIA



**PL-RCBS**  
BAR GLASS MOUNT BRACKET  
1 3/8" DIA





Ruby Glass Mount Slider System with Custom Sandblast Design





Double Door Glass Mount Slider System with Easy Locking Ladder Pulls

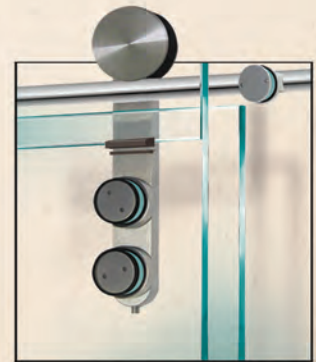

**Glass Mount**

**PL- HDSRBS  
SLIDING ROLLER**



Commercial Ruby Slider System with Custom Pulls

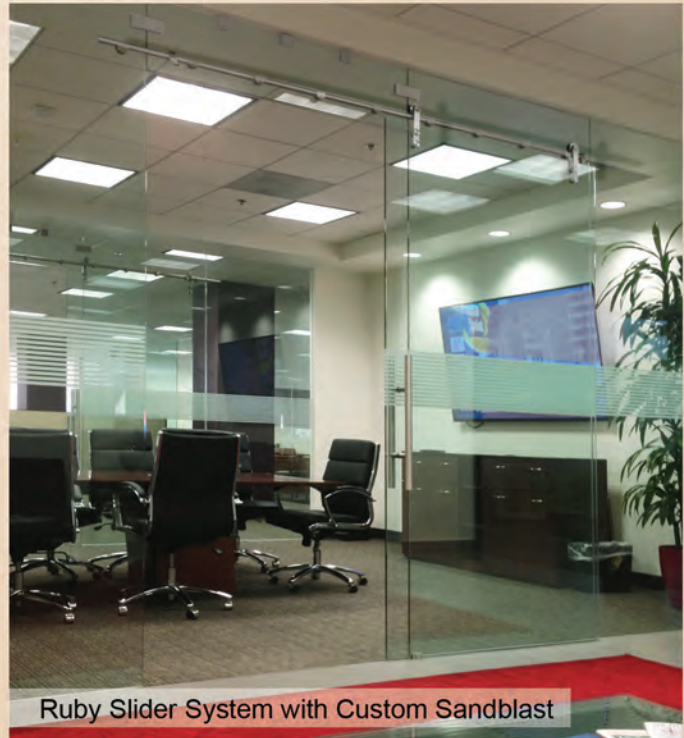

Ruby Slider System with Custom Sandblast





Wall Mount Ruby Sliding System



**Wall offset surface mount**

**PL- LSTOPBS ROLLER STOP**



Custom Oversize Wall Mount Slider System with a Max Aluminum Slider Door





P Style Bottom Roller Sliding Doors & Frameless Sidelites



P Style Bottom Roller Multipanel Sliding Doors/Sidelite System





Double Doors Sliding System with Top and Bottom Sliding Tracks

### Bottom Rollers System

PRL Sliding Systems offer unlimited options wherever valuable space and exposure is critical with:





PRL's Top Hung Movable Glass Wall System provides great design flexibility when the design intent is to maintain a secure but transparent entry that will allow for a partial or complete unobstructed opening during business hours. Heavy duty hardware allows for panels up to 264 lbs. that slide with minimal effort. Swing doors can be incorporated into the system to provide partial entry. The beauty of movable glass walls is that they operate with a single in-line track and can be stacked or hidden away in a convenient closet space. This system is ideal for restaurants, banks, office divider walls or residential patio applications where optimum view is a prime objective.



Movable all Glass Top Hung Slider/Stacking Door System



All Glass Stacking Multiple Panels System / Swing Doors Function





Clearvision All Glass Slider, Swing, Stacking Door System

- Single/Multiple Panels
- Dual Swing/Sliding
- In-line or Stacking

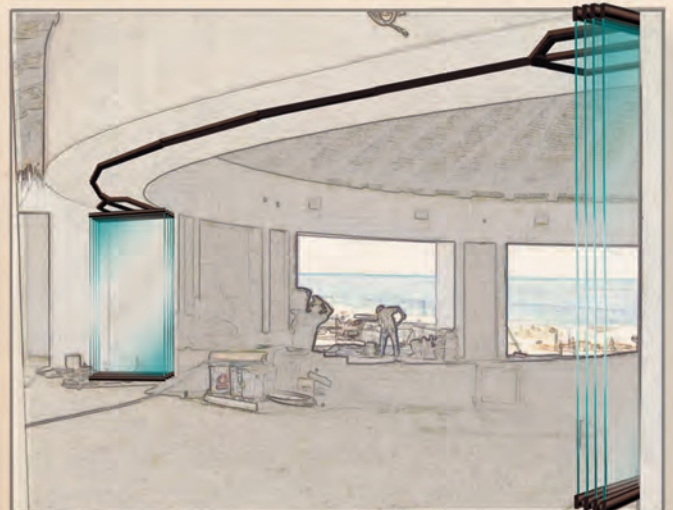
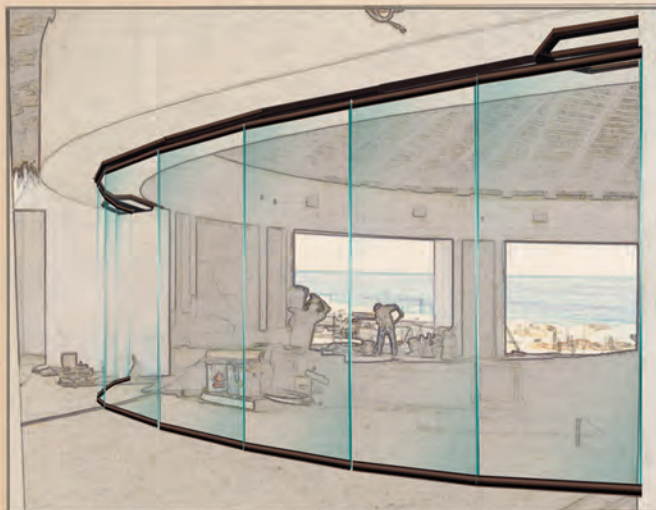



# Max' Aluminum Sliders

Luxurious, Elegant & High Performance

- Top Hung
- Bottom Roller



Max Aluminum Sliders Hospitality Project



90 Degree Multi-Panel System



Door Configurations

PRL's Max' sliding door system is a strong, versatile framed stacking system with a head/sill track, vertical jambs and bottom or top hung roller options that allow unlimited adaptability with configurations ranging from basic single pocket to multi slide configurations for areas where valuable space is critical.

**Pocket System**



Pocket system is the Max' sliders basic configuration as a one way slider. Hidden application requires designer to consider wall space requirements or the use of an optional custom offset surface mount bracket system for interior applications.

**Wall System**



This is the intermediate one way inset surface mount frame configuration that maximizes space.

In addition to the standard Max' slider features, it also offers a one piece vertical interlock system that allows sliding multiple panels at one time.



**Custom System**

Custom Slider doors will add unlimited design advantages on metal, glass and hardware options.

Other optional choices range from custom glass to exotic metal finishes. Stronger reinforced construction permits increasing door heights and widths. Please be advised there are some limitations, please consult PRL Aluminum for details.



**Multi-Track System**

Multi-Track maximizes the features of the stacking concept as two way, multiple track/panel system or corner configurations with unlimited applications. This configuration offers both standard and special features.







Max Aluminum Slider Top Hung

Slender Floor Guides

Top Hung Max Aluminum Slider

Max' Sliding Doors satisfy a wide spectrum of design and functionality requirements. Max' flexible design provides a top hung system with a slender floor guide that also offers reliable weather protection with an innovative mechanical drop seal system. Our optional concealed guide design eliminates the need for floor guide channels, where an uninterrupted floor condition is desired.

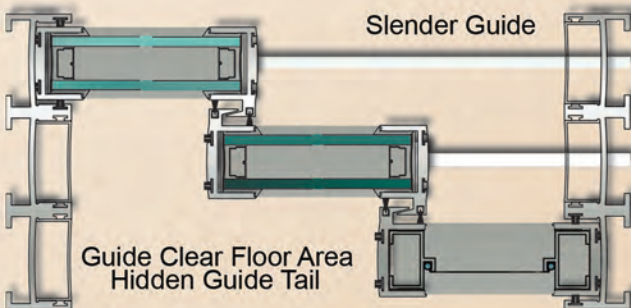

Max Slider with Slender Floor Guide





Max Top Hung System

Standard Features

- PRL's Mighty\* Top Hung Roller (\*150 lbs capacity EA)
- 3", 4" & 5" Single Extrusion Top/Bottom Rails (No Glass Stops)
  - Build to Spec.
  - Quad-Seal Interlock System
- High Performance 1 1/8" IG Glazing
  - Dual Perimeter Weatherstripping
  - 1", 3" & 5" Single Extrusion Vertical Stiles (No Glass Stops)

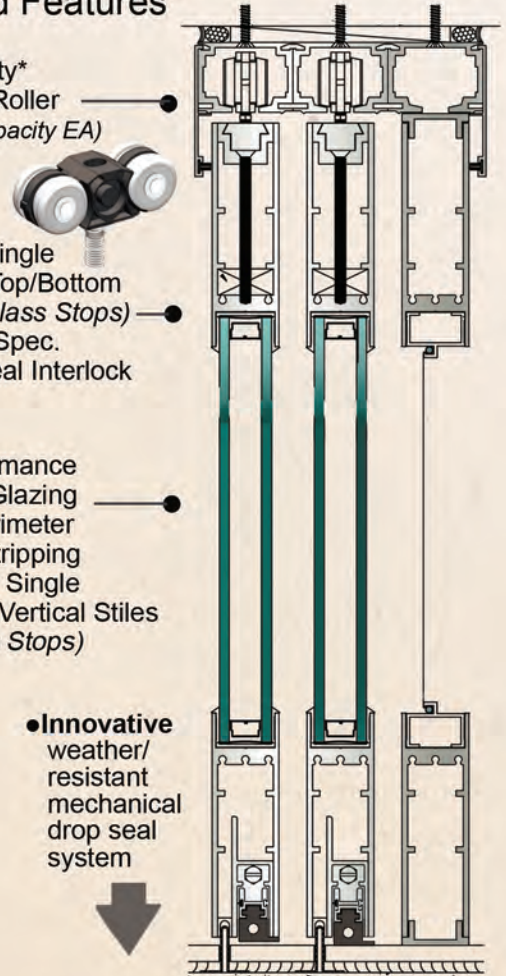

- Innovative weather/resistant mechanical drop seal system

Top Hung Options:

- Center Lock Housing (for 1" Ultra Narrow Stile)
- Bug Screen Panel
- Slender Stainless Steel Guide Exclusive Mechanical Drop Sill System

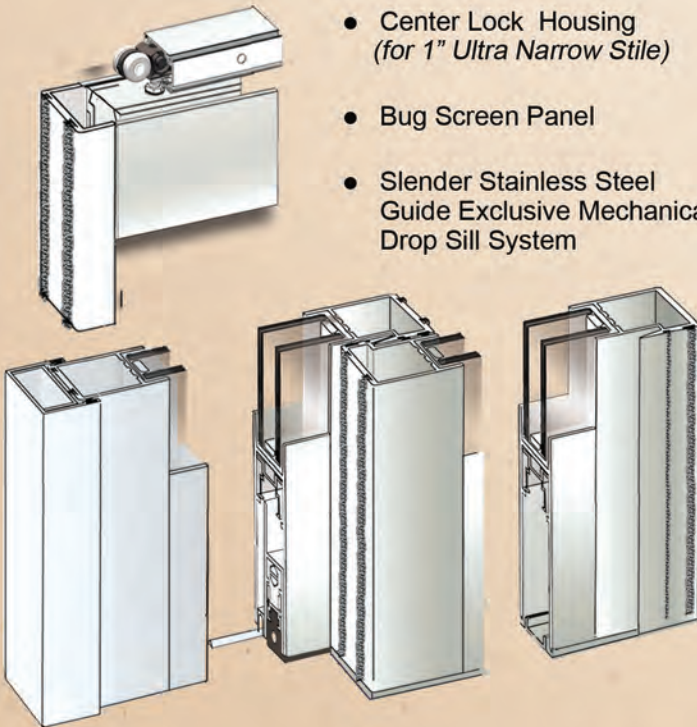

Max Slider shown with Custom Ladder Pull



Bottom Roller System

Sliding doors are used in a wide range of interior and exterior applications. Max's can be designed to suit any site conditions and design concepts. The bottom roller system offers the most flexible sliding functions.

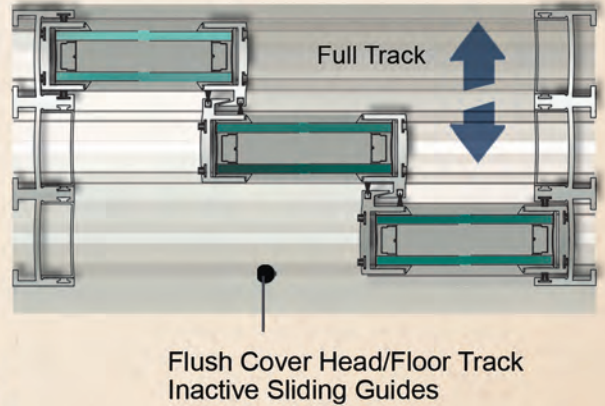





Max Multi Track In-Line Sliding System

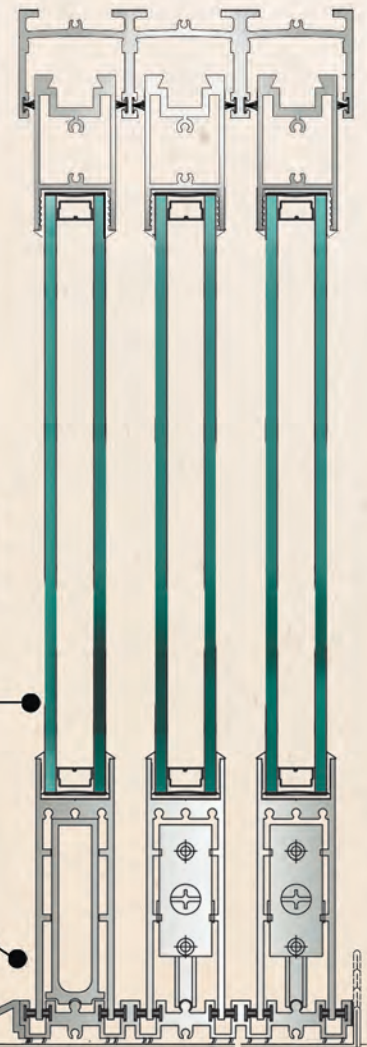

- 1/4", 3/8" & 1/2" Pocket Reducer for Safety Tempered or Laminated Glass
- Single & Multiple Head/Floor Tracks
- Floor Track Panel/Bottom Rail Dual Inset Guides
- Quad Seal Floor Track Beveled Nose (optional 1/2" or 3/4")
- Custom Sills Pans to accommodate to conditions

**Heavy Duty Grade Stainless Steel Bottom Rollers**

- 1" Ultra-Narrow, 3" & 4" Door Stiles
- High Performance 1 1/8" Std. IG Units

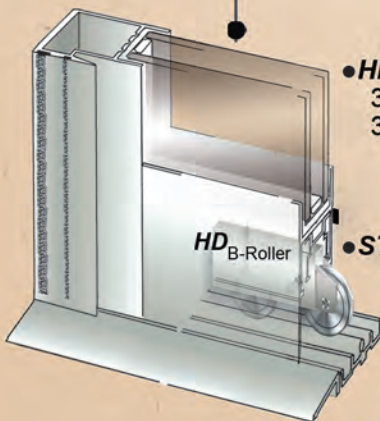

- **HD System**  
3" Roller Dia./  
350 lbs Capacity
- **STD System**  
1.5" Roller Dia./  
175 lbs ea Capacity



Max Slider with HD Bottom Roller System





Angular Configuration Max Slider Top Hung with Quad Seal Weatherstripping

## Angular Configuration

PRL's Angular Configuration Sliders are a versatile top hung or bottom rolling system. Customers are realizing the excellent quality of our Max Sliding doors and the demand for this system has increased tremendously. Our bottom rolling option with jumbo stainless rollers is well suited for large door applications. Interlocking stiles with angular configuration create a moving wall that provides open spaces, easily closed by pulling only the leading panel. The Max Slider provides superb sound control as well as excellent air and water protection, and is hurricane impact rated. It has been tested to industry standards and tried in various climate areas in the US and abroad resulting in great customer satisfaction.



Max Slider in Open Position





Max Slider 90 Degree Configuration with Slender Floor Guide

Max' sliders 90-degree angular configuration are offered for uninterrupted functionality and full extent views.

The slider system can either be two-panel or multi-panel angular bipartition configuration.

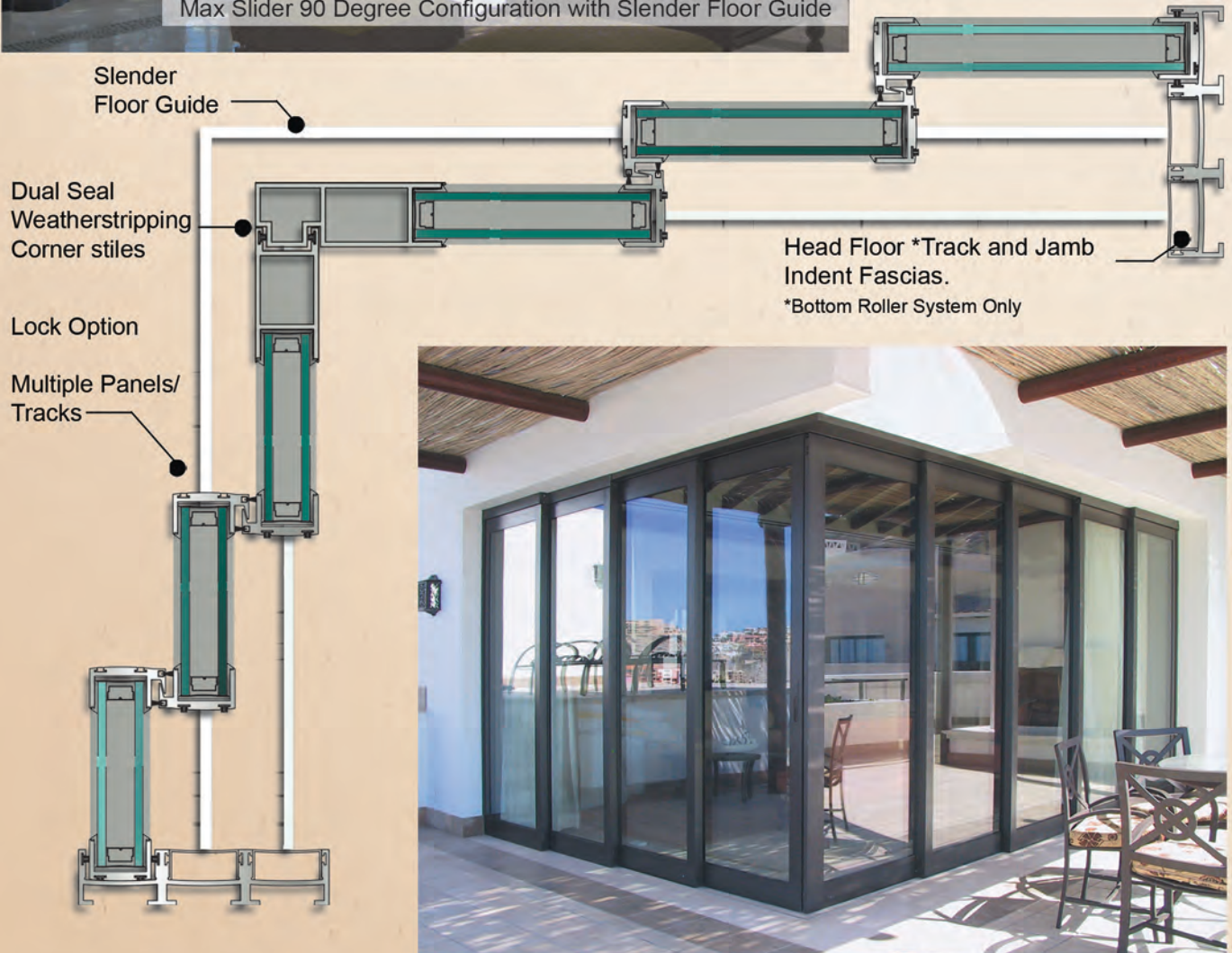



**Custom/Oversize Configurations**

Superb reinforced construction of Max' Sliders, well balanced extrusion properties and hardware qualities provide high torsional values for rigidity on custom oversized width and height applications.



Max Slider Oversize Single Door



\*Consult PRL for details

**Glass Unlimited Options**

Max Sliders glass options provide safety and high performance for any application with single panel and IG Unit combinations that range from tints, low-e and textured glass that provides high levels of natural daylight while lowering solar heat loads.



- Single Pane
- Clear
- Tinted Uncoated
- Spandrel

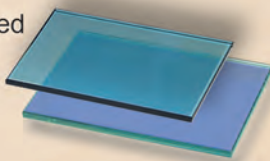

- IG Units
- Low E
- Reflective
- Laminated



- Textured
- Artistic
- Custom







Multi-Panel Max Pocket Sliding Door System

PRL's "MAX POCKET SLIDER" Aluminum Multi-panel Sliding Door continues to gain confidence and growth in the "in/outdoor living" sliding door market. Max Pocket sliding doors are designed for large glass openings and to open up the area. The Max Slider provides superb sound control as well as excellent air/water protection and is hurricane impact rated.

A number of different rail and stile profiles are available including an "ultra thin" 1" stile. Glass options include 1/4" to 1 1/8" thick IG. Made in the USA, completely in-house, this product is LEED friendly.

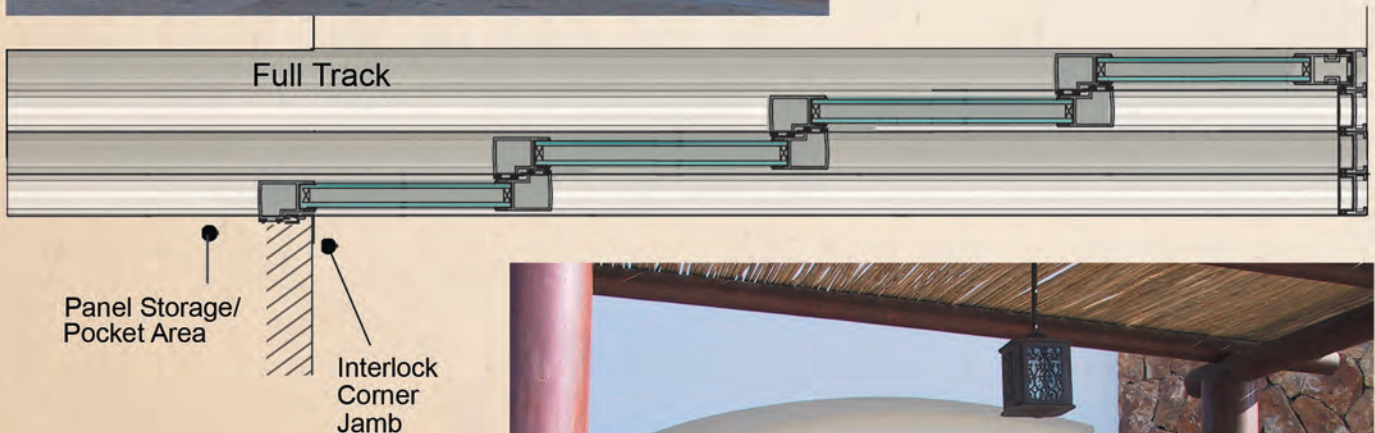

- High Performance  
1 1/8" Std. IG Units
- Single & Multiple  
Head/Floor Tracks
- **HD** Bottom  
Roller System  
Floor Track Panel/Bottom Rail  
Dual Inset Guides  
Quad Seal Floor Track  
Beveled Nose (optional)



Fully Concealed Panels Unobstructed Opening



## Max' Aluminum Sliders Options Stiles



Angular Configuration Max Slider

Various vertical stile size options are offered for unlimited adaptability and narrow sight vertical lines with standard 1 1/8" performance glazing. Glazing pocket adaptors are available for particular designs or applications.



### Vertical Door Stiles

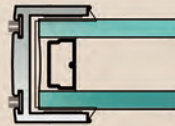

1" Ultra-Narrow



3", 5" Std



1/2" and 9/16" (Lami) Glass Options  
Pocket Adaptor

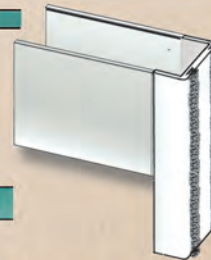

Max Slider System with Centerlock Housing

Max' Sliders offer deadbolt and jamb bolt locksets for access control and security, which also accommodates flush mount finger pulls and well balanced pull hardware.



\*Custom Lock housings are available

### Lock Hardware



Std. Flush Lockset/  
Centerlock Housing\*  
\*Ultra Narrow stile only  
1/2" x 3 1/4" Lock Faceplate



HS Two Point  
Deadlock  
3/4" x 11 3/4" Faceplate





Max Slider shown with Deep Finger Custom Pull



**CANCUN (CN\*)**



**ACAPULCO (AC\*)**



**DEEP FINGER (DFP)**  
1 5/16" w / 9" h



**CABO (CB\*)**



**STANDARD (STD)**  
10" c/c

**Pull Hardware**

Max Sliding door locksets can be paired with standard flush escutcheons, luxurious stainless steel deep/bolder flush finger pulls, or custom pull hardware.

Pull sets in luxurious finishes are available, providing a balanced closing and opening effort on multiple panel systems.

\*Custom sizes, technical/functional limitations apply. Consult PRL for details



### Versatile Applications

Max's sliders are flexible and will suit various applications including large opening sliding windows on dwellings with astounding views that will integrate outdoors to enclosed areas.

Sliding Units as room partitions will offer unobstructed openness functionality when required, obscurity with a spandrel rich color variety or designer texture glass to add a luxurious appearance.

- Pantries
- Partitions
- Sliding Windows

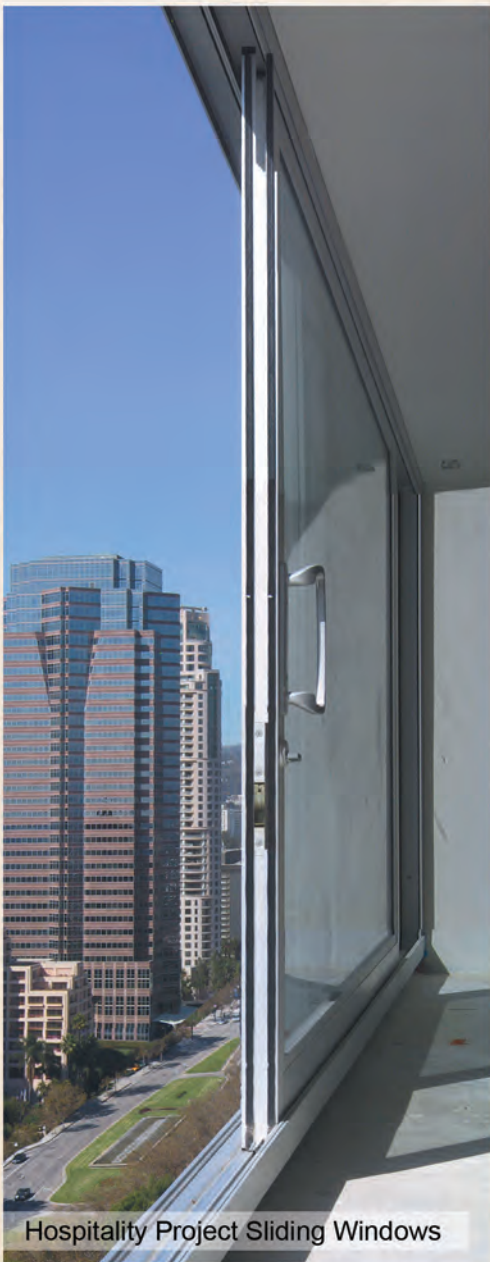

Hospitality Project Sliding Windows



Max Slider Custom Window Configuration



Oversize Sliding Window



Closed/Open Air Restaurant Application





Max Slider with Custom Wood Grain Coat



Clear Anodized



Bronze Anodized



Custom Graphic  
Wood Grain Coat



White Powder Coat  
& Custom Colors

Max' sliders are offered in several finishes to match or harmonize with most architectural or decor styles. Clear, dark bronze anodized and white/black powder coat are standard finishes. Custom finishes like custom color painted or graphic wood grain are offered upon request. Some custom finishes present limitations, please consult PRL Aluminum for details.





Commercial Entrance Aluminum Slider



Max' sliders allows unlimited adaptability with the basic single pocket to multi slider configurations, in-line or 90 degree applications.

They provide the finest quality and functionality when combined with high performance glass, which will add excellent energy efficiency values/NFRC ratings.



### High End Residential

PRL Max Sliders are designed and tested for Commercial and Residential applications. Our heavy-duty design makes them suitable for larger door sizes and our high quality hardware allow for a smooth and quiet operation.



Max Aluminum Slider





Interior/Exterior  
Grade

AAMA Product Basic Designation  
Exterior Ratings:  
R-PG15-SD for low profile sill  
CW-PG35-SD for top roller  
CW-PG45-SD for bottom roller  
NFRC for high performance glass

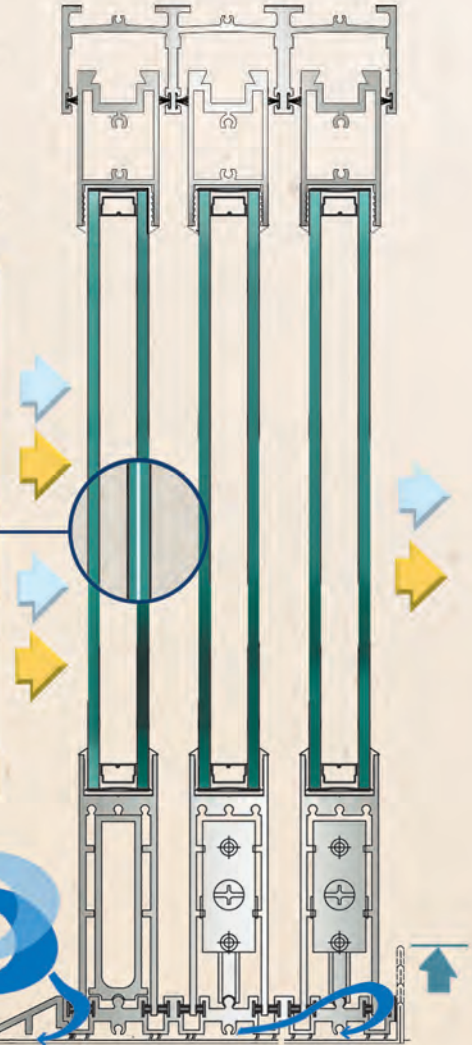

Weather Resistance Features

Max sliding doors are designed to resist above average weather conditions. PRL technology provides weather tight features that minimizes water and air infiltration through the gaps based on the industry standards requirements.

Both PRL Aluminum extrusions and weather stripping technology have proven to be exceptional performers at the laboratory controlled tests conditions and at demanding weather conditions in pacific coastal areas.

Max sliders offer the advantages of effective water-resistance for luxury homes and resort installations.

Some project conditions may require even tighter weather resistance, accessories and architectural alternative designed elements and modifications are also available.

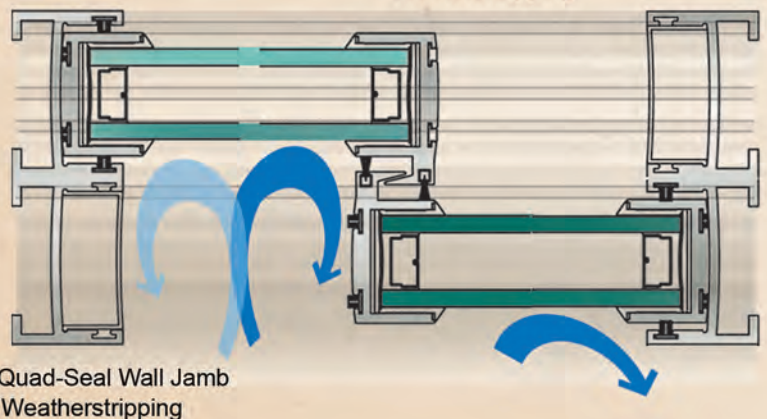



Shower Sliders

Nu-vision shower sliders are offered in 1/4" & 3/8" glass thickness, standard heights or custom configuration to fit almost any project condition. Sliders are assembled with precision engineered metal extrusions for heavy glass load.

- Sandblast Design
- Custom Configuration
- SD Hardware
- Texture Glass



Standard Shower Slider



Tiffany Shower Slider



Ruby Shower Slider





Tiffany Shower Slider



Ruby Shower Slider with Custom Gluechip & Sandblast



Custom In-Line Shower Slider



Standard Shower w/Master Carre Glass/ORB Finish



**Nu-Vision Frameless Shower Units**

PRL's shower door units are fabricated to exact size, selected thickness and configuration to fit your opening and finished to match the dwelling décor. The frameless shower enclosures and steam units will give bathrooms a distinctive look. The all glass frameless units enhance the beauty of bathroom tile or marble work. Nu-Vision Frameless Shower door units feature tempered safety glass in every application.



Custom Single Door Application



Custom Steam Unit



3/8 Interior Custom Application



Custom Neo-Angle SD Enclosure





Custom Enclosure with PL-SD8 Pull & 3/8" Starphire



Shower Enclosure Units with Clear/Acid Etch Glass



SD 90 Degree Unit with 1/2" Starphire Glass



Neo-Angle SD with BN Hardware





Custom SD Single Doors with Sandblast Glass



In Line SD Unit with 3/8" Rain Glass



**MASTER-RAY**  
5/16"



**MASTER-CARRE**  
3/8"



**MASTER-POINT**  
5/16"



**MASTER-LENS**  
5/16"



**MASTER-LIGNE**  
5/16"



**SANDBLASTED**  
3/8", 1/2"



**ACID ETCH/MATTE**  
3/8", 1/2"



**GLUECHIP**  
3/8", 1/2"



**RAIN**  
3/8"



**CUSTOM GLUECHIP**  
SB DESIGN

Note: Samples shown are for illustration purposes only, color/designs may vary from actual samples. Please consult PRL for details and availability.



We offer a complete and exclusive Line of PRL hardware for Shower Sliders, Steam/Tub Units and Swinging Shower Door Units that include a wide selection of styles and standard finishes.

**Hinges** *Wall mounts*

*135-180 Degree*

*Pivot*



Beverly  
PL-TB074



Contoured  
PL-CWM



Devine  
PL-DWM



Sidney  
PL-TSHD074CH



Bella  
PL-TBHD044



Beverly  
PL-TB180



Contoured  
PL-C180



**Pulls**

**Pull/T-Bar**



Contoured  
PL-C



Standard  
PL35DS



Mini Ladder  
PL-MLP



Contemporary  
PL-CTP



Standard Combos  
PL8SD618



Towel Bar  
PL-18SSTBBN

**Knobs**

**Clamps**



Standard  
PLKNOB



Sliders  
PLKDDBN



Beverly  
PL-BK



Bow  
PLBSK



Beverly  
PL-TBC



Contoured  
PL-CC



Sade  
PL-TSC

**Headers**

**U Channels**

**Seals**



Contoured Shower  
Door Header  
PL-CSDH10



1/2' Channel  
12UCH



3/8' Channel  
38UCH



Drip Wipe Rail  
PL-38BS/12BS



Double T-Seal  
PL-DBLT

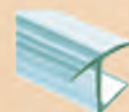

Strike/Door Jamb  
PL-180SJ



Rail Wipe  
PL-RW

\*some restrictions apply, consult PRL for details.



# GUARDRAILS/HANDRAILS

## Flex Post Series

### Multiple applications:

- 36", 42" & Custom Post Heights
- Grip set 1/2" glass clamps
- Polished/Satin stainless steel finishes
- Floor Mount Bracket/Flange cover
- In line, 90/135 corners & end options
- 1 1/2"-2" dia. top cap option

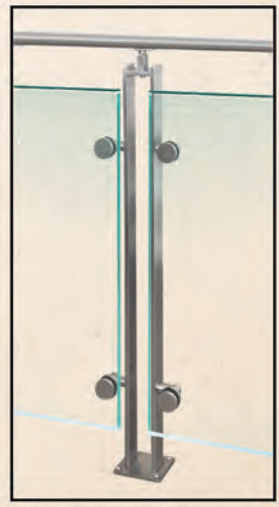
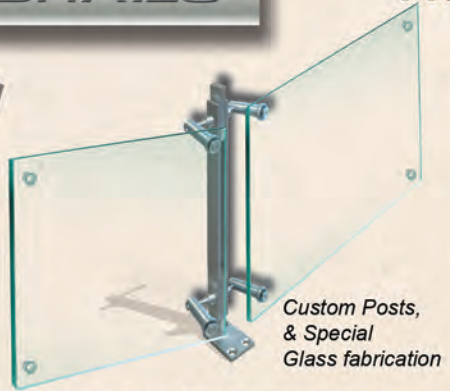

**PL-PRS180BS**  
2" Dia. Top Cap

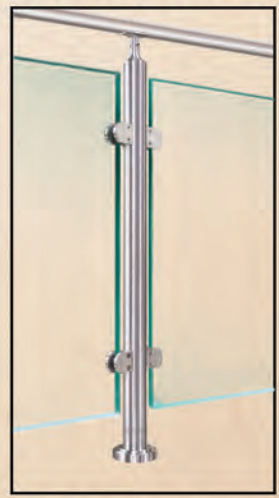

**PL-PFS180BS**  
2" Dia. Top Cap

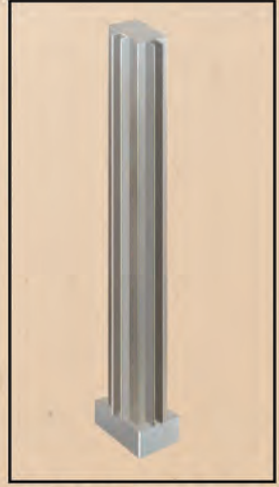

**CUSTOM GLASS POST**

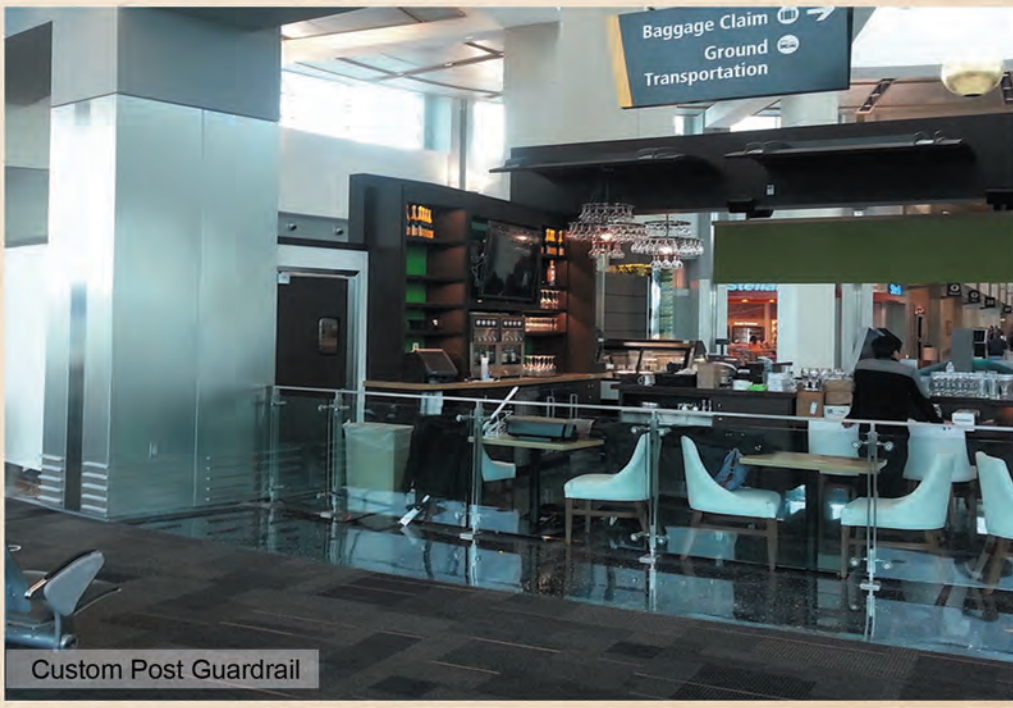



**Infinity Floor Post Mount**  
*Aluminum Modular Railing*

Offering, easy installation solutions & the best systems in the industry! For 1/4" and 3/8" glazing.

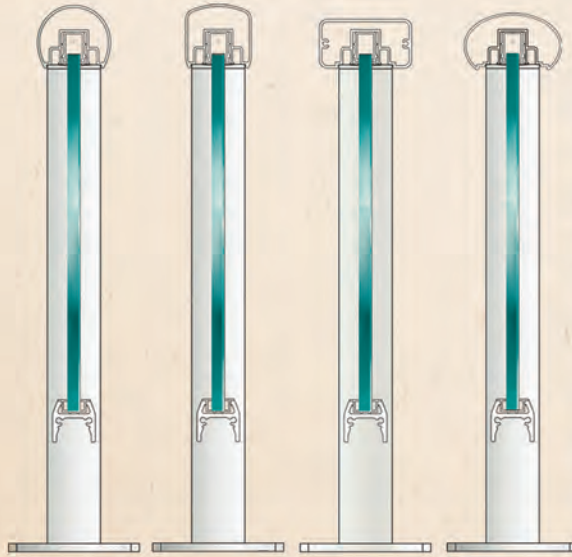

**Series      200      250      300      350**



Infinity Handrail Project



Infinity Floor Post Mount Handrail System with Laminated Glass



## Stand-off Surface Mount System

### Elegante Stand-Off

The Elegante Railing System brings innovation to the Architectural and Design Industry. This system is unique due to its frameless features, using 1/2" tempered glass or laminated glass and 2" diameter standoffs made of 316 alloy stainless steel.

Depending on the structural substrate, 4" x 8" back plates may be required. The back plates have predrilled holes to ease installation and adjustments. Custom lengths and diameters are available upon request.

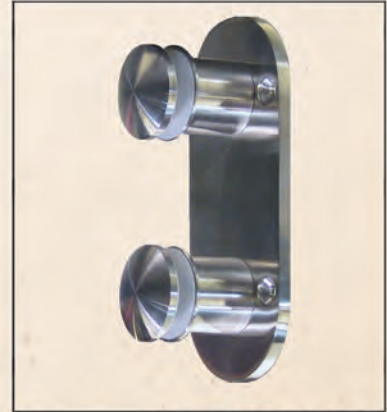

**PL-R2SOBD20BS**  
Round Mount Bracket  
for 2" Standoff



**PL-RSOBD20BS**  
4" w x 8" h SQ. Corners  
Round/Flat Cap



**PL-RSOBD2134BS**  
2" Dia S  
Flat / Round Cap



Custom Length Standoff





Elegante Stand-off System with Round Cap



Elegante System with Square Mount Bracket and Flat Cap



PRL offers a variety of standard and custom Guardrail/Handrail components,

Top Cap/Glass Mount (brakeformed/aluminum)	Offset Glass Panel Mount
Tubular/Wall Mount	Custom Design
Bottom Base wet/dry-set glazing	Brakeformed/clad



Elegante Glass System with Offset Mount Handrail



**PL- HR20XCGPS**  
Wall/Glass Mount Bracket  
for 1 1/2" Dia. rail



**PL- HR20XDWBS**  
Adjustable wall mount  
HR Bracket for 1 1/2" Dia Tubing



**PL- HR20XEGPS**  
Adjustable Glass Mount  
HR Bracket for 1 1/2" Dia Tubing



**PL-HR15RE/HREC**  
90 deg. 1.5" Dia.  
Endcap/Return Elbow

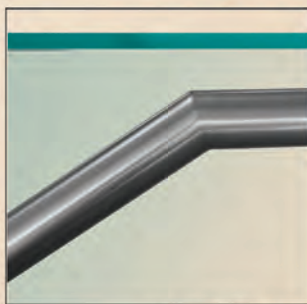

**PL-HR135E**  
Elbow 1.5"/1.9" Dia.

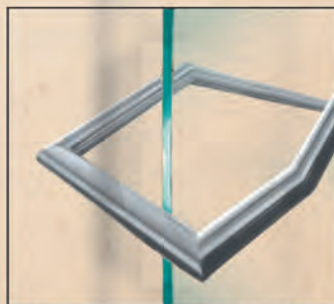

**PL-HRCE**  
1.5"/1.9" Dia.  
Custom Angle Return



**PL- HR15**  
1 1/2" Dia./ 2" Dia.  
HR Round Tube



### Finishes

Complete handrail systems are offered in several finishes to match or harmonize with most architectural or decor styles. Mill finish aluminum, Clear anodized are standard. Custom Clad or painted finishes are available upon request. Some finishes present limitations, please consult PRL Aluminum for details.



Clear Anodized/  
Mill Finish



Bronze Anodized



White Powder Coat



Polished/Brushed  
Stainless Steel



Polished/Brushed  
Naval Brass\*

\*No lacquer

### Top Caps

#### Brakeformed

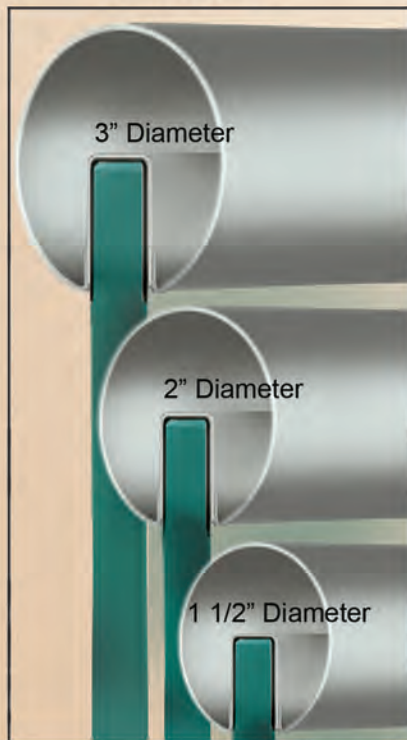

**PL- TCBS**  
HR/GR Top Cap

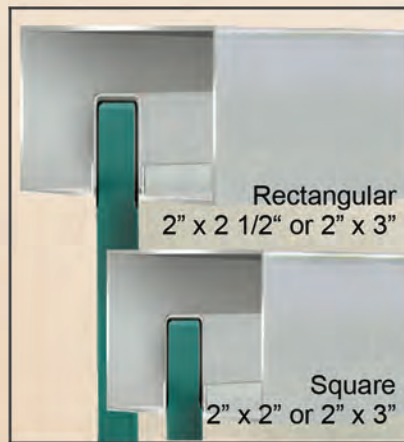

**PL- SQTC**

#### Extruded Aluminum



**PL-ATC**  
Aluminum 2" Top Cap

HR/GR top caps metal & finishes are,

**Extruded Aluminum**  
Mill, Clear and Bronze  
**Powder Coat**  
White

**Stainless Steel** (Brake-formed clad)  
# 8 polished, #4 satin  
**Naval Brass**  
Polished & Satin

We also offer custom fabrication, machining and finishing services, as well as variety of standard & custom components.



**Mighty Mini Rapid Dry-set**  
Precision Bolt Assembly

**Features:**

- 2 3/4" height
- Proven to be the easiest & fastest installation
- No special tools required
- Easy removable/exchangeable drop on cover plates
- Anodized, clad or painted
- Dry Set or wet glazed
- 10', 20' ft. or extrude to custom lengths

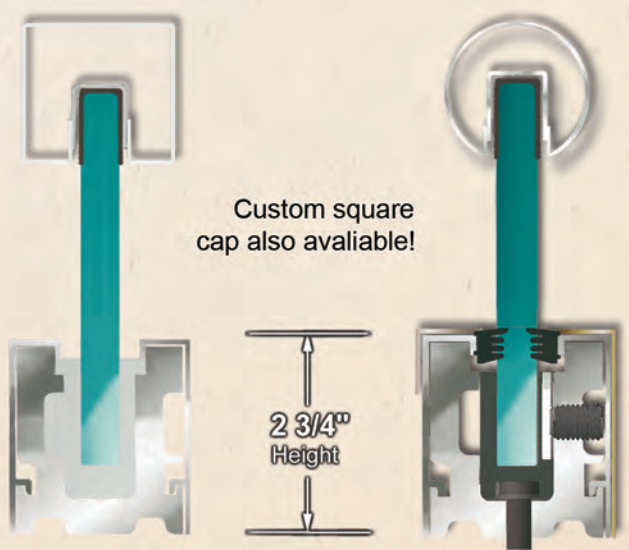

**PL- DSMHRB**  
2 1/2" w x 2 3/4" h





### Rapid Dry-set (Precision Bolt Assembly)

PRL's dry-set system offers:

- Shoe base lighter
- Optional clad fascia
- Stock length sizes 10' 12' & 20' custom size available
- Fast, easy reduced labor installation
- No additional/special tool required
- Plumb adjustment up to 5/8" Right side/vertically

1/2" Glazing

3/4" Glazing

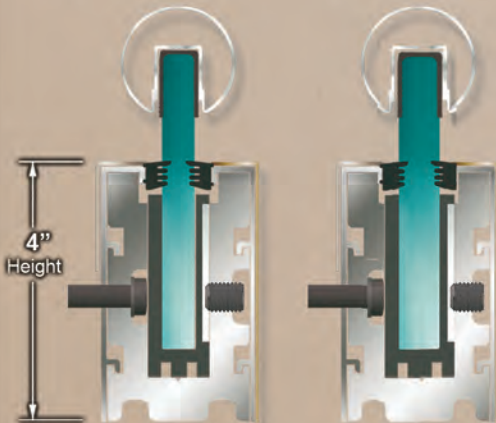

PL- DSHRB / PL-TC  
2 1/2" w x 4" h

PL- DSMHRB  
2 1/2" w x 2 3/4" h

"Lighter, fast & easy installation"

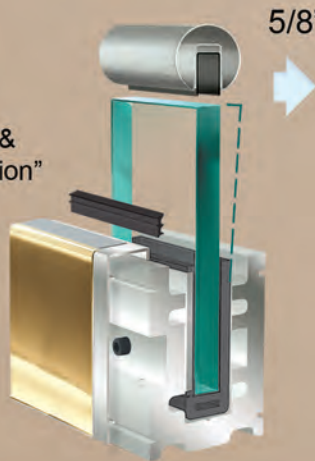

9/16" Sentry Glass with Round Top Caps



Custom Sandblast 3/4" Glass on Rapid Dry-set Handrail System





All Glass Fence System



Glass Fence with Custom Gate System



Glass Gate with CLH Glass/ Digital Key-Pad



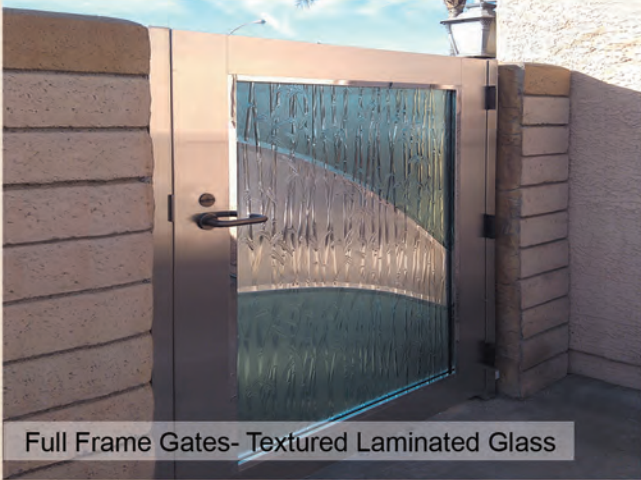

Full Frame Gates- Textured Laminated Glass



Access Gates- ARI Laminated Series



Aluminum Gates- Acid Etched /Diamond Seal



Security Gates



Access Control Gate- Sandblast Design Logo



**Mirror**

PRL enhances the mirror elegance with

- Polished
- Beveled
- Multiple bevels
- Sandblast artwork



Oversize Wall Mirror



Rectangular Low-Iron Mirror



Custom Mirror Configuration



Oversize Starphire Mirror



**Low Iron Mirror**

PRL offers a full-service glass and mirror fabrication. We offer 1/4" Low Iron Mirror that is ultra-white with an incomparable clarity and no tint. When it comes to custom mirrors, PRL specializes in fabricating custom mirrors to your specifications. The latest trend are mirrors with etching for back lighting or for creating a seamless mirror wall.



Seamless Mirror Wall with Etching

**Clear Mirror vs Low-Iron Mirror**



Custom Low Iron Wall Mirror with Custom Cutouts

**Features:**

- Brighter
- Excellent clarity
- Color-less

**Unlimited Applications:**

- Gym
- Beauty Salon
- Designer Couture
- Hospitality
- Event Halls
- Boutiques
- Spas





Custom Round Table Top with Flat Polished

### Tabletops

PRL custom tabletops have contributed to complete tasteful and refined decor. Custom shapes and edging on heavy glass reflects PRL expert craftsmanship. Offering, standard geometry, complex shapes, overlay and custom inset (frame or pattern are required).

Among other applications are

- Residential  
Dining  
Coffee
- Office  
Conference  
Desk
- Commercial  
Display  
Countertop



Tinted Glass Countertop



Round Tabletop Custom Mount





Oversize Tabletop with Custom Shape & Artistic Glass Base



Oversized Conference Tabletop with Custom Edge



### Glass/Aluminum Walls & Dividers with unlimited glass options such as:

- Clear
- Tinted Uncoated
- Sandblast
- Spandrel
- Bullet Resistant
- Low E
- Reflective
- Textured
- Laminated
- Custom



Aluminum & Glass Wall Divider



Wall Partition with PL-375 Clad Rails

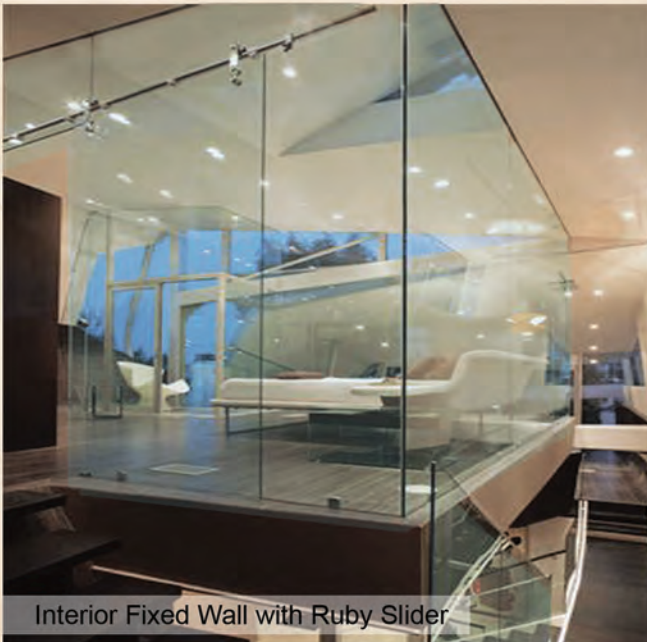

Interior Fixed Wall with Ruby Slider

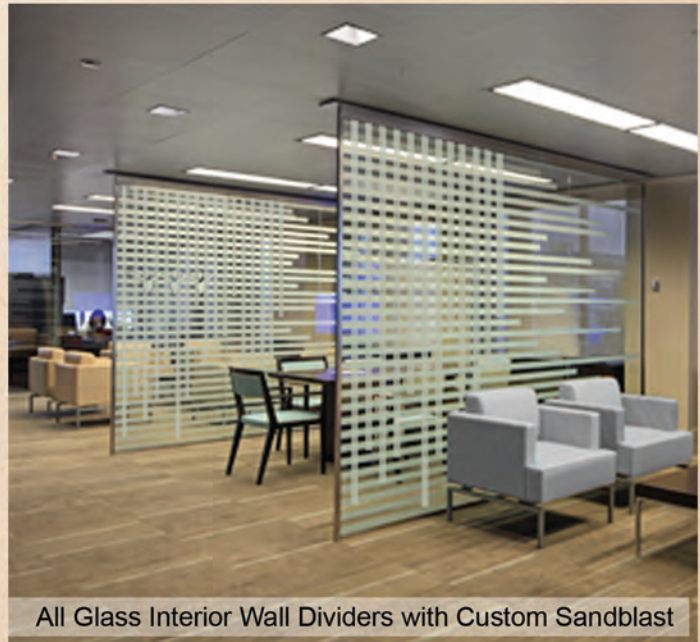

All Glass Interior Wall Dividers with Custom Sandblast





Custom Office Aluminum & Glass Interior Walls



Glass Panel Column Cover

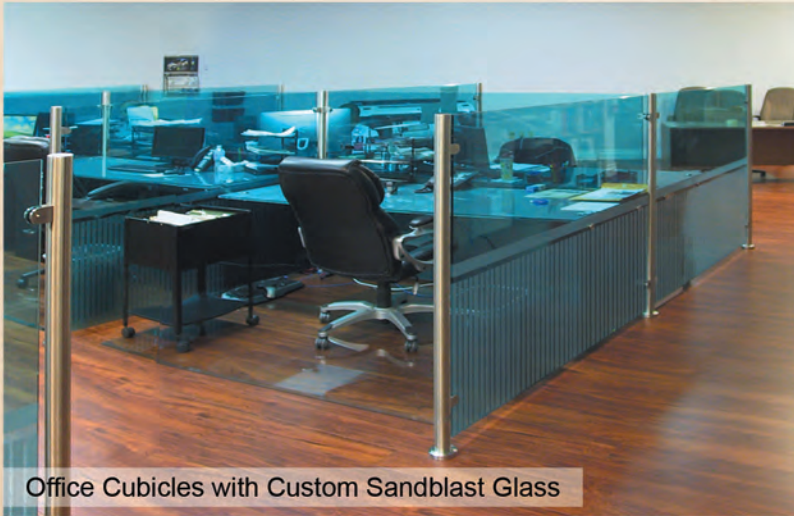

Office Cubicles with Custom Sandblast Glass



Custom Glass Wine Cellar

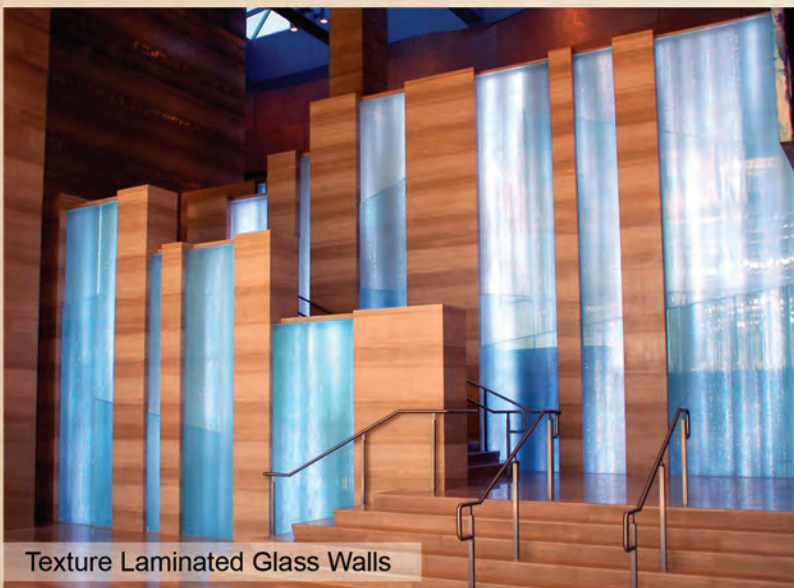

Texture Laminated Glass Walls



## Sandblast

PRL Sandblast artwork enhances glass elegance with surface or deep carved custom designs such as, logos applications, floral designs, mythical concepts, abstract, contemporary designs, or ornamental design. Applicable in most of our product line such as, entrance doors, slider systems, tabletops, shower enclosures, decorative glass, handrails, and many others.

- Carved
- Artistic
- Custom
- Surface Sandblast
- Custom edges
- Tri-Dimensional Sandblast



Three Dimensional Sculptured Sandblast Mythical Art Design



Entrance System Ornamental Design



Interior Doors with Gradient Sandblast



Glass Partition with Custom Design





Handrails Border Artwork

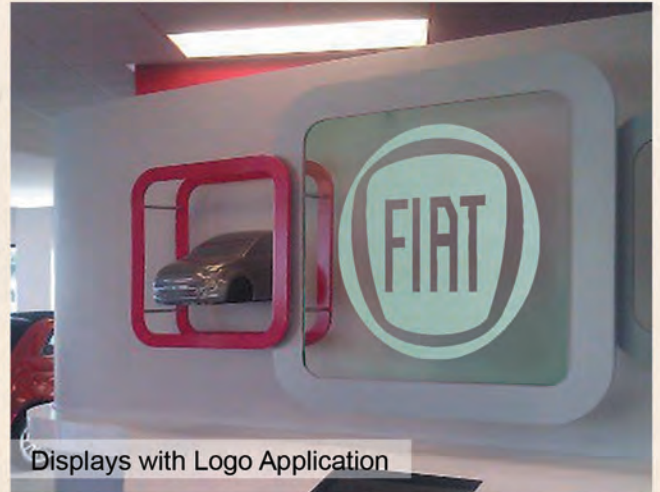

Displays with Logo Application



Entrance System Contemporary Artwork



Partition Oceanic Design



Detail sandblasting checked pattern on a Tiffany Slider with lock Housing/CB Pull.





### Sound Control

PRL "Sound-Control Laminated Glass" is manufactured with a special acoustic grade PVB interlayer.

This unique interlayer has advanced the technology for high-grade acoustic control. When used with IG multiple combinations, extraordinary sound reduction can be obtained.

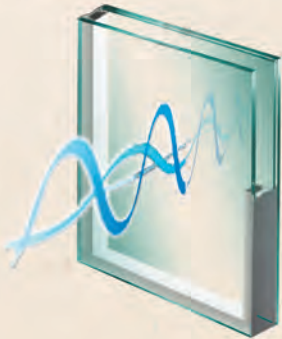





Custom Interlayer with Fused Wood Veneer

**Decorative**

PRL's custom Laminated Glass has contributed to complete tasteful and refined décor with unlimited adaptability to unique design concepts, such as:

- Elaborated shapes
- Pattern cutting
- Third party hardware/ elements
- Oversize
- Special glass (Lami thick/ Color combination)



Laminated Glass with Lace Interlayer

**Bullet Resistant**

PRL's new safety and bullet-resistant glass is thinner and lighter than all other similar products on the market. It uses Makrolon polycarbonate to provide no-spall ballistic protection, while the Marnot anti-weather polycarbonate provides scratch resistance. PRL's bullet resistant product has been tested and conforms to the requirements of UL752.S. It has been design to meet Level 3 ballistic resistance, and is only 1-inch thick.

- 1" Thickness & Lighter Alternative
- Full Range / No Spall Protection
- Polycarbonate Scratch Resistance
- High Ballistic Resistance without Excessive Weight



Safety Bullet Resistant





Structural SentryGlas®

PRL offers fabricated laminated glass with SentryGlas ionoplast interlayer. This is a very durable interlayer with superior resistance to weathering, moisture intrusion and sealant contact problems. It is significantly stronger and more rigid than standard PVB interlayers, making it ideal for impact rated and structural applications.



Security Structural Gate



Custom Laminated Tempered Glass Panels



-  1 CORAL ROSE
-  2 AQUAMARINE
-  3 SMOKE GRAY
-  4 SAHARA SUN
-  5 RUBY RED
-  6 SAPPHIRE BLUE
-  7 EVENING SHADOW
-  8 GOLDEN LIGHT
-  9 DEEP RED
-  10 TRUE BLUE
-  11 TANGERINE
-  12 OCEAN GREY

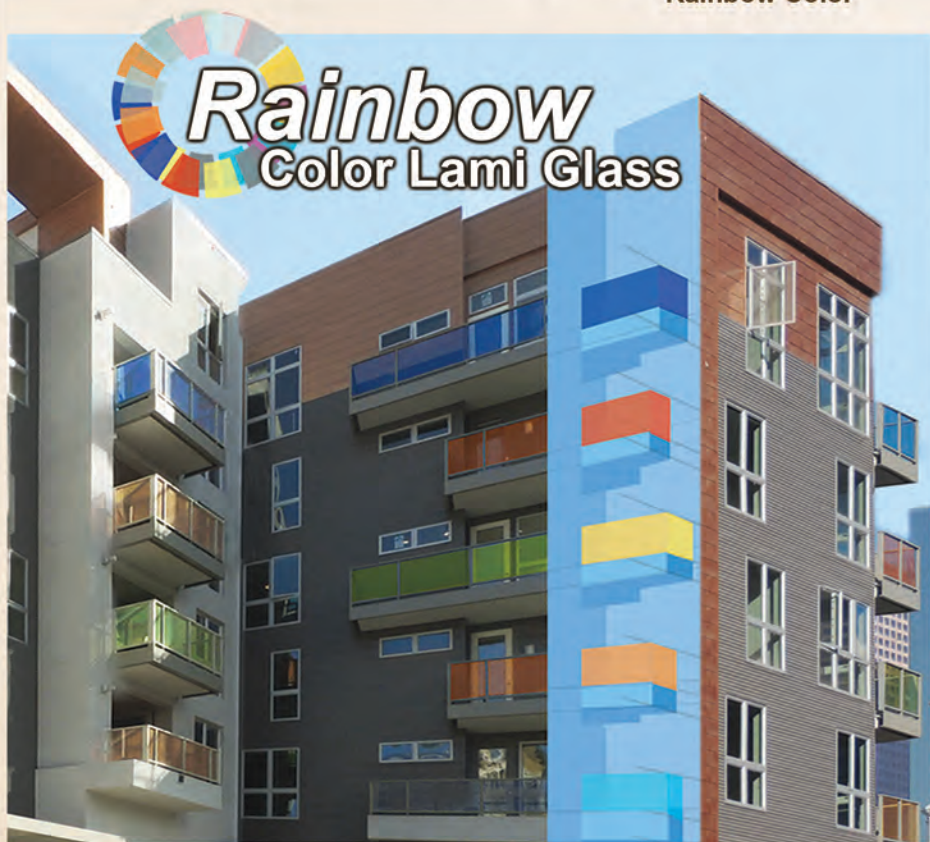

### Rainbow Laminated Glass

Rainbow laminated colors can give you the color you are looking for. Rainbow color interlayer provides 13 standard earth tone color shades that can be used interior and exterior applications. These shades were created to match industry glass tints. The standard colors can be combined to produce over 1,000 transparent or opaque colors. Now architects and designers can design their own color with so many options. The laminated color glass interlayer are fade resistant.



Custom Translucent Wall/Divider in Sapphire Blue



Custom Interior Wall with Custom Colors



PRL laminated glass is ready to assist you with your Tempered, Safety, Sentry, Bullet Resistant, Missile Resistant & Hurricane Resistant glass requirements. PRL offers a lighter, stronger safety glass that can stand up to greater threat levels.

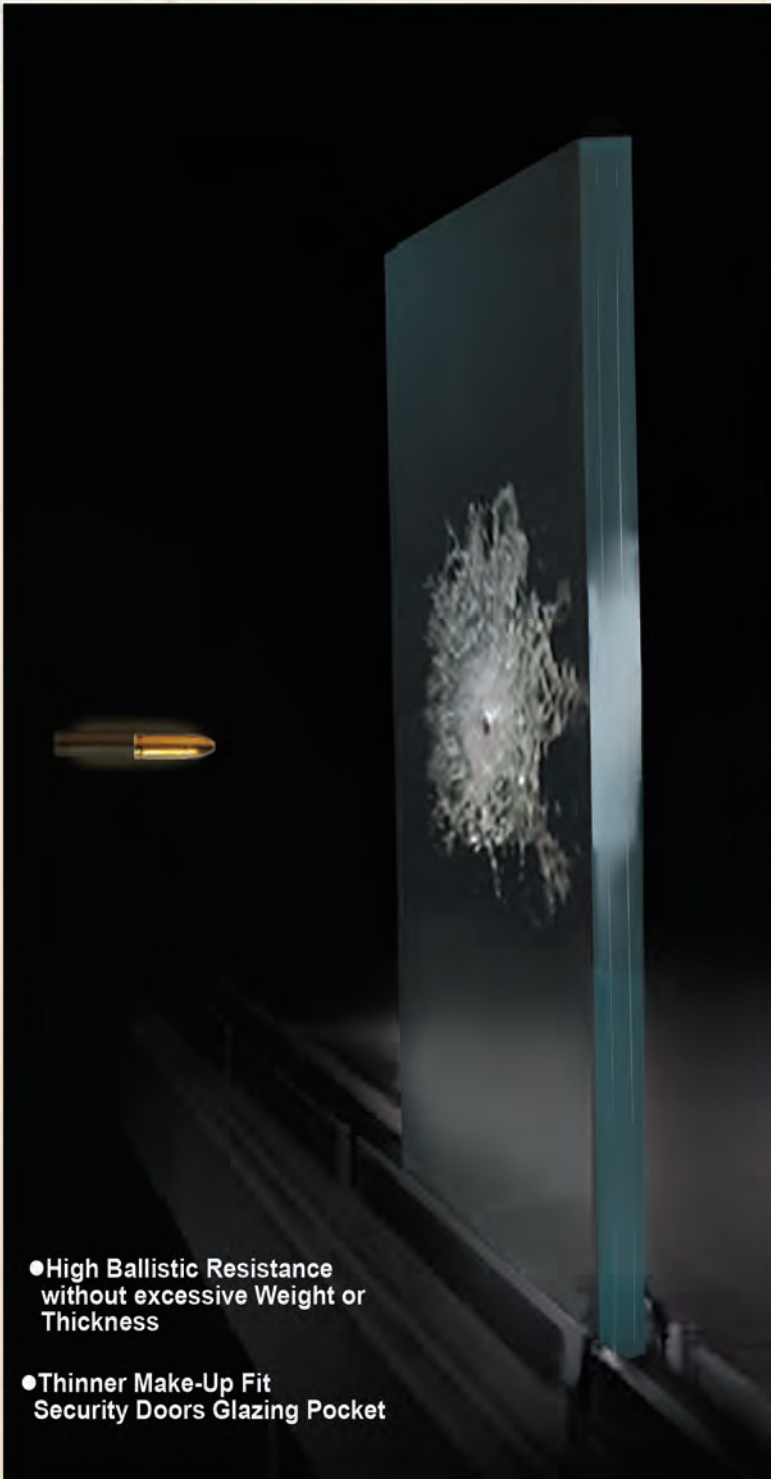

- High Ballistic Resistance without excessive Weight or Thickness
- Thinner Make-Up Fit Security Doors Glazing Pocket

Bullet Resistant

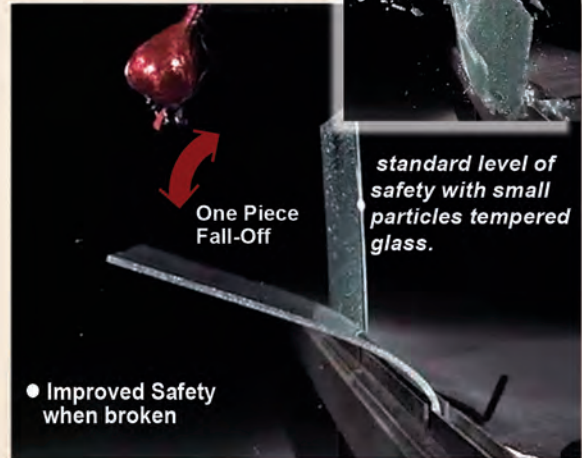

- Improved Safety when broken

Tempered/PVB Laminated Glass



- Tolerates high stress loads (bolted & frameless).
- Reduces deflection & withstands greater wind forces.

Tempered/SentryGlass®

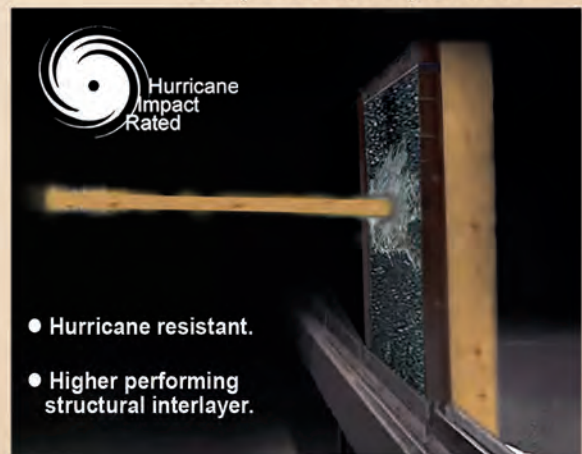

- Hurricane resistant.
- Higher performing structural interlayer.



Missile Impact





Our Max Slider Systems include PRL's Aluminum Extrusions, glass and weather-stripping technology. This technology provides weather tight features that narrows the gap of acceptable water and air infiltration compared to the industry standards/requirements.

### ZONE 3 suitable

-  Wind Zone III (200mph)
-  Hurricane-Susceptible Region



*Our sliders passed the tests in laboratory controlled conditions.*

*\*test reports available upon request*





**Exterior Applications**



Curtainwall Infill Panels

Offered with ICD OPACI-COAT 300 water based silicone coat, which is not heat-treated.

Applicable on annealed, tempered glass, & reflective glass products. Available in standard and custom colors, Please contact PRL for details.

SPANDREL glass is available in an almost unlimited range of colors provides a variety of options for interior glass applications. Used on clear, low-iron or reflective glass it can add a radiant, jewel-like color to commercial or residential interior applications.

Glass Shown:  
#0-0186  
Light White/Clear



**Standard Colors**

	#1-818 Black		#1-0016 Charcoal
	#3-820 Harmony Gray		#3-0586 Medium Gray
	#4-822 Harmony Bronze		#3-0770 Warm Gray
	#6-0025 Harmony Blue		#3-747 Harmony Graylite#14
	#2-743 Harmony Solex		#3-967 Black-Gray
	#4-975 Lava Bronze		#4-0925 Neutral
	#2-0225 Evergreen		
	#0-0186 Light White		#2-0213 Aged Copper
	#0-0020 Snow White		#6-0194 Fjord
	#0-1060 Primary White		#5-936 Red

**Custom Colors**

**Wall Clad & Interior Decorative Applications**



Back Wall & Cabinets Fascia

Note: Samples shown are for illustration purposes only, colors may vary from actual samples. Please consult PRL for details and availability.



Decorative Wall Panels



Decorative Counter Top





Spandrel Panels Custom Color Wall Interior Glass Application



Foyer Backwall shown with Custom Color Spandrel





Curtain Wall with Clear Glass



Wall Divider with Custom Gradient Sandblast Glass

PRL offers one of the widest selections of Low Iron glass thicknesses available including 3/16", 1/4", 3/8", 1/2", 5/8", and 3/4" Starphire stocked in jumbo sheet sizes and ready for fabrication as monolithic, laminated or insulated units.



**STARPHIRE**



**CLEAR**



**CUSTOM**  
Gluechip/Sandblast



**I.G. UNIT**  
Energy performance



**BULLET RESISTANT**



**LAMINATED**  
Custom Makeups





**Texture Glass**

PRL offers a wide collection of high quality texture glass ideal for showers, transoms, kitchen cabinets, room dividers, sidelights, partitions or places where you want light to enter but still have some privacy.

Note: Samples shown are for illustration purposes only, color/designs may vary from actual samples. Please consult PRL for details and availability.



**WATER FLEMISH**  
1/4"



**ACID ETCH**  
3/16", 1/4", 3/8"  
(Low Iron -3/8", 1/2")



**DELTA FROST**  
5/32"

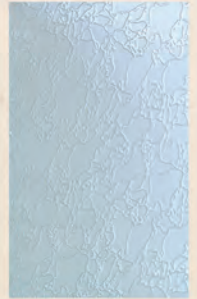

**DELTA CLEAR**  
5/32"



**RAIN**  
3/6", 1/4", 3/8"



**P-516**  
1/8", 5/32", 3/16",  
1/4"



**CLEAR GLUECHIP**  
3/16", 1/4", 3/8",  
1/4"



**REEDED**  
(1/2" space apart)  
3/16", 1/4"



**AQUATEX**  
3/16"

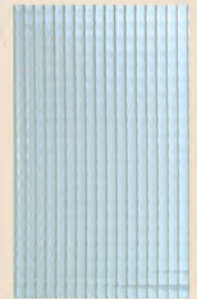

**CROSSREED**  
(1/2" squares)  
3/16"



**BAMBOO**  
3/16"



**BAMBOO FROST**  
3/16"



**MISCO WIRE**  
1/4"



**KRYSTAL PEBBLES**  
5/32"



**KRYSTAL DELTA**  
5/32"



**KRYSTAL DELTA FROST**  
5/32"

**KRYSTAL SERIES**





Accordion Bi-Fold with Mirrow View Reflective Glass & Custom Sandblast

**Reflective Glass**

A pyrolytically coated glass for improved solar control, tinted glass allows natural light to penetrate a building while limiting the amount of sun damaging ultra-violets rays and infrared energy (heat) that enters. Available in 1/4" only unless otherwise noted.

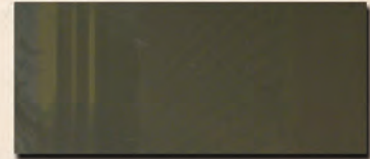

**BRONZE ECLIPSE**  
1/4"



**SOLARCOOL GRAY**  
1/4"

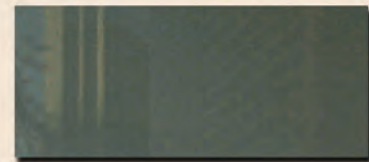

**SOLARCOOL AZURIA**  
1/4"

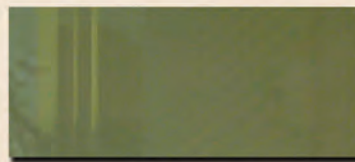

**SOLARCOOL SOLEXIA**  
1/4"

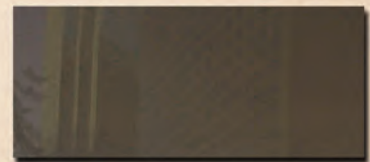

**SOLARCOOL BRONZE**  
1/4"

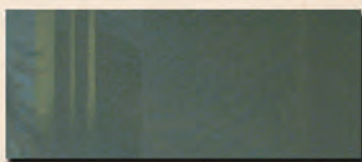

**SOLARCOOL SOLARBLUE**  
1/4"



**EVERGREEN ECLIPSE**  
1/4" (Advance low\_e)

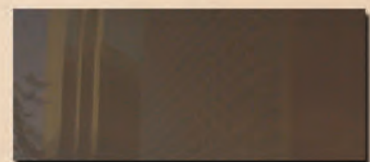

**MIRROR PANE**  
1/4"

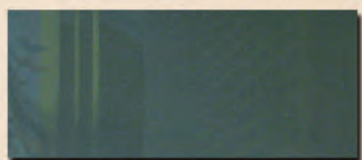

**SOLARCOOL PACIFICA**  
1/4"

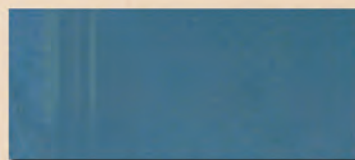

**VISTACOOOL PACIFICA**  
1/4"



**MIRROR VIEW**  
1/4"

All Sheet Size:measures 96" x 130"





Note: Samples shown are for illustration purposes only, colors may vary from actual glass samples. Performance data is available upon request. Please consult PRL for details and availability.

**Tinted Uncoated Glass**

Provides excellent solar control with a versatile range of tints. Offers high levels of natural daylight while lowering solar heat loads. Available in 1/4" or in other thicknesses if noted.\*

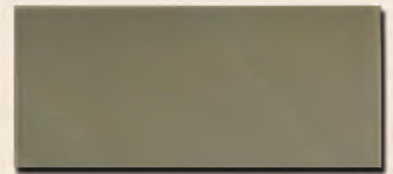

**BRONZE**  
\*1/8", 3/16", 3/8" & 1/2"

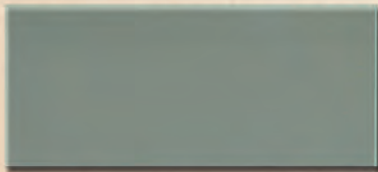

**SOLEXIA / GREEN**  
1/8", 3/16", 1/4"

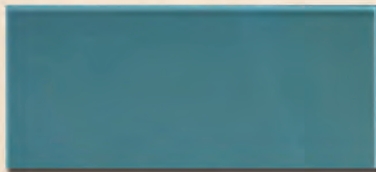

**AZURIA**  
1/4", 3/8"

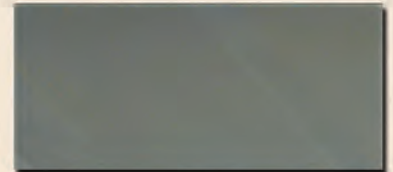

**GRAY**  
\*1/8", 3/16", 1/4", 3/8" & 1/2"

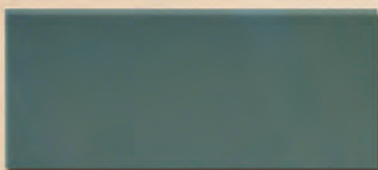

**BLUE GREEN**  
1/4", 3/8"

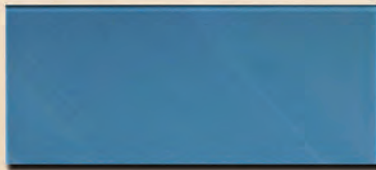

**PACIFICA**  
1/4"

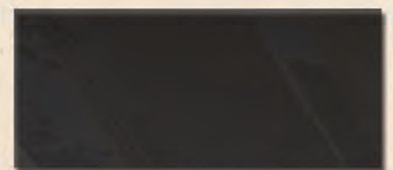

**GRAYLITE II**  
1/8", 1/4"

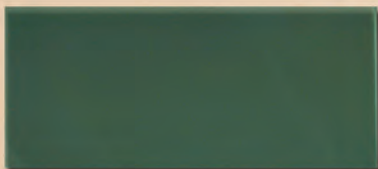

**EVERGREEN / ATLANTICA**  
1/4"

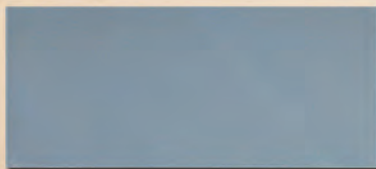

**SOLARBLUE**  
1/4"

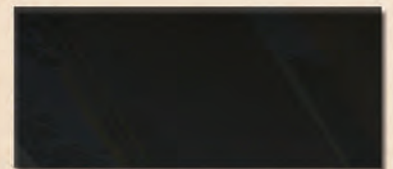

**SUPER GRAY**  
1/4"

All Sheet Size: measure 96" x 130"





PLCW-600 Series with Low E Clear Glass IG Units

PRL Aluminum Curtain Wall Systems (PL-CW600, 700 and 1000) offer a structural solution when standard storefront is insufficient to meet size and load requirements. Our Curtain Wall is designed and engineered for maximum performance and highest quality assurance. We offer complete systems including doors, sub-frames, hardware and glazing.

- Aluminum/All Glass
- Custom Extrusions
- Complete Storefront System
- CNC Fabrication
- Hardware
- Custom Breakmetal
- Architecture Glass  
IG Units  
Tempered Glass  
Spandrel



PLCW-700 with SNX 68 Super Neutral Glass

Curtain Wall Series

- PLCW-600 - 2 1/2" x 6"  
1" Offset Glazed
- PLCW-700 - 2 1/2" x 7"  
1" Offset Glazed
- PLCW-1000 - 2 1/2" x 10"  
1" Offset Glazed



PLCW-600 Series with Pacifica Tinted Glass





Sectional Structure with PLCW-600 Series

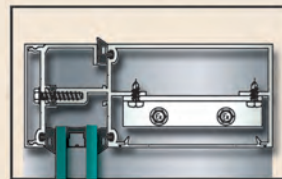

HEAD

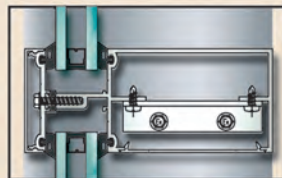

HORIZONTAL

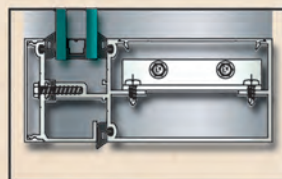

SILL



Curtainwall System with Reflective Glass

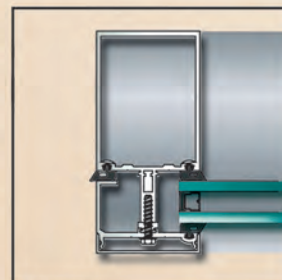

JAMBS

Features

- Versatile
- Structural
- Energy efficient
- Custom design
- Fastest design/mfg

\*Please Consult PRL for details





Custom Storefront Doors with Custom Pulls

**Storefront Series**

- 201** 2" x 4 1/2"  
1/4" Offset Glazed
- 250** 2" x 4 1/2"  
1" Center Glazed
- 251** 2" x 4 1/2"  
1" Offset Glazed
- 400** 1 3/4" x 4"  
1/4" Center Glazed
- 401** 1 3/4" x 4"  
1/4" Offset Glazed
- 450** 1 3/4" x 4 1/2"  
1/4" Center Glazed

**Custom Doors & Storefronts**

- Shop Drawings Service
- All Hardware Options Available
- Glass Unlimited Options:
  - Clear
  - Textured
  - Tinted Uncoated
  - Spandrel
  - Sentry
- Low E
- Sandblast
- Reflective
- Laminated
- Custom



250 Series Entrance System with Full Height Ladder Pulls





Custom Storefront with Special Finish



Storefront with PL-3 Offset Pulls



201 Storefront Series Custom System





251 Series Steel Stiffener Reinforced with Atlantica IG Units



250 Series with Coastal Custom Paint



250 Series with Vistacool Reflective Glass IG Units





400 Series with Medium Stile Aluminum Doors



250 Series Framing with Wide Stile Doors



251 Series with Sentry Laminated Glass



### 250 SERIES

2" x 4 1/2"  
1" CENTER GLAZED

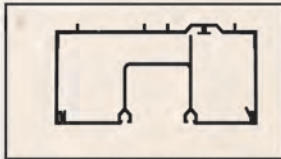

**HEAD**  
NAME  
PART NUMBER  
LENGTH

HEAD ASSEMBLY  
250HCA  
24'-1"

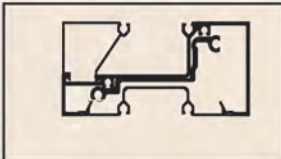

**HORIZONTAL**  
NAME  
PART NUMBER  
LENGTH

HZ ASSEMBLY  
250HMA  
24'-1"

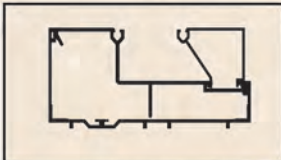

**SILL**  
NAME  
PART NUMBER  
LENGTH

SC ASSEMBLY  
250SCA  
24'-1"

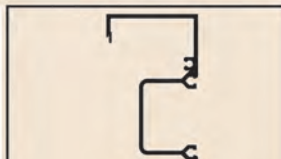

**JAMBS**  
NAME  
PART NUMBER  
LENGTH

WALL JAMB  
250TJ  
24'-1"



**135**  
**CORNER**  
**POST**

NAME  
PART NUMBER  
LENGTH

135 CPOST  
250NCPA  
24'-1"

### 400 SERIES

1 3/4" x 4"  
1/4" CENTER GLAZED

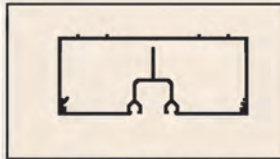

**HEAD**  
NAME  
PART NUMBER  
LENGTH

HEAD ASSEMBLY  
400HCA  
24'-1"

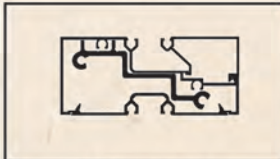

**HORIZONTAL**  
NAME  
PART NUMBER  
LENGTH

HZ ASSEMBLY  
400HMA  
24'-1"

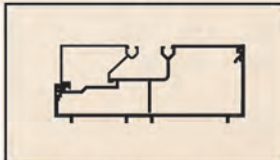

**SILL**  
NAME  
PART NUMBER  
LENGTH

SC ASSEMBLY  
400SCA  
24'-1"



**JAMBS**  
NAME  
PART NUMBER  
LENGTH

DOOR JAMB  
400DJ  
24'-1"



**FLAT**  
**CORNER**  
**POST**

NAME  
PART NUMBER  
LENGTH

FLAT CORNER POST  
400FCPA  
24'-1"

### 450 SERIES

1 3/4" x 4 1/2"  
1/4" CENTER GLAZED

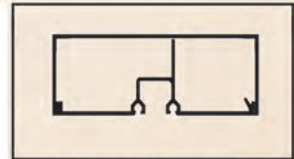

**HEAD**  
NAME  
PART NUMBER  
LENGTH

HEAD ASSEMBLY  
450HCA  
24'-1"

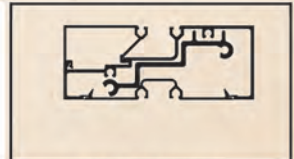

**HORIZONTAL**  
NAME  
PART NUMBER  
LENGTH

HZ ASSEMBLY  
450HMA  
24'-1"

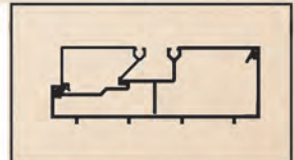

**SILL**  
NAME  
PART NUMBER  
LENGTH

SC ASSEMBLY  
450SCA  
24'-1"

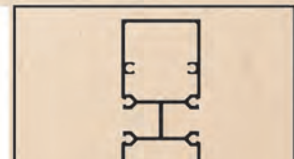

**JAMBS**  
NAME  
PART NUMBER  
LENGTH

VERTICAL MULLION  
450VM  
24'-1"



**MISC**  
NAME  
PART NUMBER  
LENGTH

CORNER POST (2P)  
450DBCP  
24'-1"

**MATERIAL:** 6063-T5 aluminum alloy.

**FINISH:** Standard finishes are mill, clear and bronze anodized. All others are special order.

**NOTES:** Storefronts are available in quick set or screw race, please consult PRL aluminum for details



**201 SERIES**

2" x 4 1/2"  
1/4" OFFSET GLAZED

**251 SERIES**

2" x 4 1/2"  
1" OFFSET GLAZED

**401 SERIES**

1 3/4" x 4"  
1/4" OFFSET GLAZED

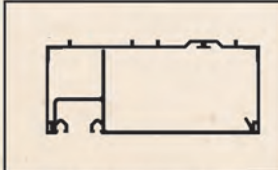
HEAD NAME PART NUMBER LENGHT	
	HEAD ASSEMBLY
	201HCA 24'-1"

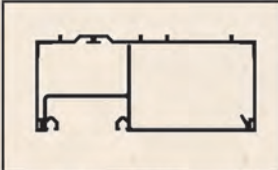
HEAD NAME PART NUMBER LENGHT	
	HEAD ASSEMBLY
	251HCA 24'-1"

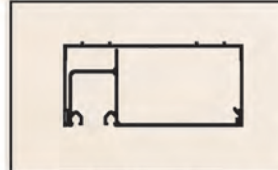
HEAD NAME PART NUMBER LENGHT	
	HEAD ASSEMBLY
	401HCA 24'-1"

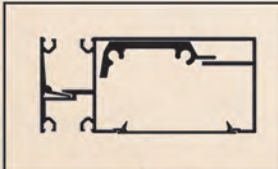
HORIZONTAL NAME PART NUMBER LENGHT	
	HZ ASSEMBLY
	201HMA 24'-1"

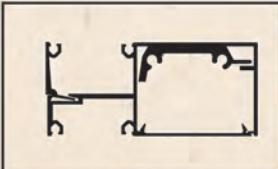
HORIZONTAL NAME PART NUMBER LENGHT	
	HZ ASSEMBLY
	251HMA 24'-1"

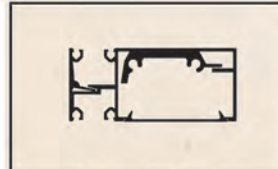
HORIZONTAL NAME PART NUMBER LENGHT	
	HZ ASSEMBLY
	401HMA 24'-1"

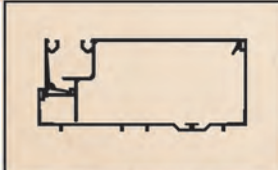
SILL NAME PART NUMBER LENGHT	
	SC ASSEMBLY
	201SCA 24'-1"

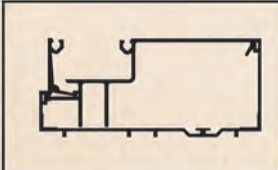
SILL NAME PART NUMBER LENGHT	
	SC ASSEMBLY
	251SCA 24'-1"

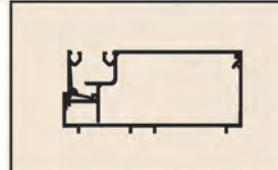
SILL NAME PART NUMBER LENGHT	
	SC ASSEMBLY
	401SCA 24'-1"

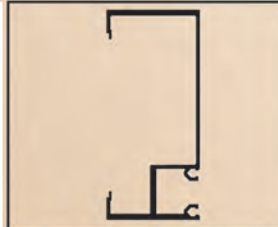
JAMBS NAME PART NUMBER LENGHT	
	WALL JAMB
	201WJ 24'-1"

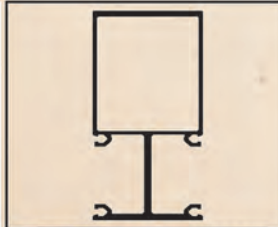
JAMBS NAME PART NUMBER LENGHT	
	VERTICAL MULLION
	251VM 24'-1"

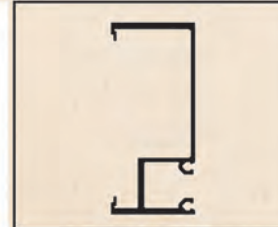
JAMBS NAME PART NUMBER LENGHT	
	WALL JAMB
	401WJ 24'-1"

**MATERIAL:** 6063-T5 aluminum alloy.

**FINISH:** Standard finishes are mill, clear and bronze anodized. All others are special order.

**NOTES:** Storefronts are available in quick set or screw race, please consult PRL aluminum for details





Full Frame Colossal Atrium Entrance System

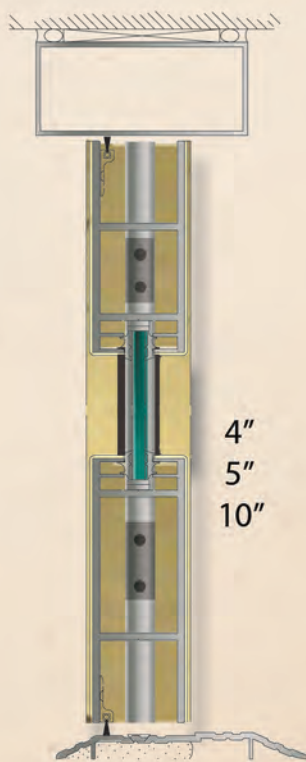

Top/Bottom rails

### Full Frame Doors

PRL Full Framed Entrance Systems offer a wide selection of options to create a grand entrance. Whether it's a pair of Full Framed Clad Doors, a Monumental Entrance with several pair, or a Colossal Atrium Entry, we provide complete systems with doors, frames, glass and all related hardware.

- Seamless top and bottom rails.
- Narrow, Medium, Wide, or I-Line all Seamless vertical stiles
- Interior or Exteriors applications
- Luxurious Cladded finishes as well as custom painted
  - Satin & Polished (304 Stainless steel / 464 Naval brass)
  - Oil rubbed bronze(US10B)
  - Powder coated or Kynar Painted
  - Custom finishes available
- Unlimited selections of glass options
  - 1/4" to 3/4" tempered or laminated
  - 1" insulated units
  - Pattern glass
- Specialty Hardware that will complete your design requirements
  - Offset/CH pivots
  - OH concealed closer
  - Floor closer
  - Butt hinges
  - Door holders
  - Panic devices
  - Custom pulls
  - Fabricated Thresholds



**Full Frame  
Styles**



Oversize Monumental Clad Frame Doors with Ladder Pulls



**NARROW**  
3" vertical stile,  
4", 5", 10" or  
custom height  
top/bottom rails



**MEDIUM**  
4" vertical stile,  
4", 5", 10" or  
custom height  
top/bottom rails



**CUSTOM**  
narrow vertical stile, top/bottom  
rails, hardware, glass and  
sandblast artwork.



**MUNTIN**  
custom intermediate  
vertical/horizontal  
muntin

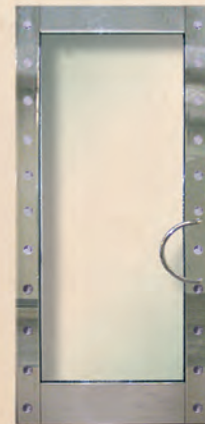

**STAMPED**  
Custom Stamped  
pattern



**WIDE**  
5 1/2" vertical stile,  
5", 10" or  
custom height  
top/bottom rails





Medium Style Clad Offset Doors with Custom Pulls



Wide Style Clad Doors with Offset Ladder Pulls



Full Frame Doors in Satin Stainless Steel Finish with VD Panic Hardware and Offset Ladder Pulls





Custom Doors with Dead Bolt Device



Oversized Door Clad in Black with Laser Cut Design



Wide Style Doors with Custom Finish



Medium Style Doors with ARI Custom Laminated Glass



All Glass Entrance System

PRL all glass doors are available in various standard styles and are offered with continuous rails or corner patch combinations. Available metal finishes are stainless steel, brass (satin or polished), anodized aluminum and powder coat or Kynar painted.



P Style Door / Entrance System with Custom Shape Ladder Pulls



P Style Door System with Full Height Ladder Pulls

\*Standard Configurations



**P-**  
Continuous horizontal top and bottom rails from any PL-Series rails.



**BP-**  
Corner patch rail in a 9 1/2" from any PL-Series rails or PL Euro series fittings, continuous horizontal bottom rail from any PL- series rails.



**F-**  
Corner patch rails at pivot and lock points in a 9 1/2" section from any PL-Series rails or PL-Euro series fittings.



**A-**  
Corner patch rails at pivot points (no lock patch) in a 9 1/2" section from any PL-Series rails or PL-Euro series fittings.

Custom Door Designs are also available for a wider variety of applications.





Complete Entrance System with Stabilizer Fins,  
Floating Header, and PL Panic Device





2 1/16" W x 10 1/8" H  
**PL-1000DS**



2 1/16" W x 6" H  
**PL-600DS**



2 1/16" W x 4 1/4" H  
**PL-350DS**



2 1/16" W x 4 1/4" H  
**PL-150DS**

**Precision Bolt Assembly System**

- Interchangeable faceplates easy to replace:  
Damage/scratched material  
Aesthetic changes
- Low cost (face only)
- Fast door assembly & easy adjustment  
without door removal
- Finishes  
Aluminum anodized  
(Clear, dark bronze)  
Clad, Stainless/brass polished or Satin.  
(Painted or Custom Finished)
- Available for 1/2", 5/8", 3/4" glass

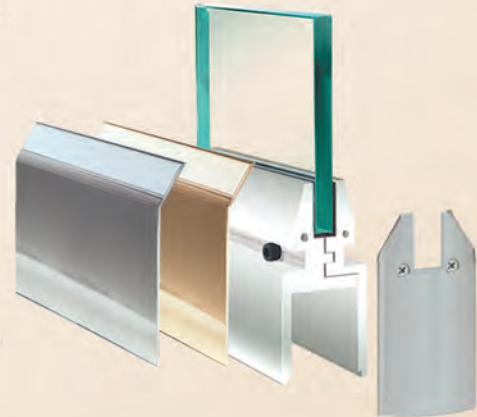

P-Style Entrance System with PL-150DS Dryset Rail & Ladder Pulls



P-Style Entrance System with PL-1000 DS Bottom Rails & 24" Ladder Pulls



**Rapid Dryset**  
Sidelite Header/Rail



Fixed Panels with Gradient Sandblast & PL-150 Dryset Sidelite Rail

**Dryset Rails**

- Anodized Finishes  
Clear & Bronze
- Clad Finishes  
Stainless Steel & Naval Brass
- Powder Coat (Available)
- Custom Heights
- Setting Tracks
- Endcaps
- DS Vinyl

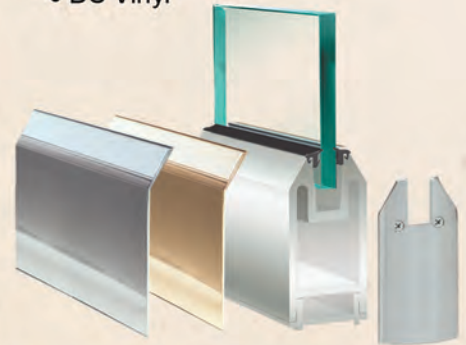

2 1/16" W x 4 1/4" H  
**PL-150SDS**



2 1/16" W x 4 1/4"-6"-10" H  
**PL-350/600/1000SDS**



Fixed Panels with Clear Glass, Full HT Fins & PL-350 DS Rails



**Sidelites Header**

- Anodized Finishes, Clear & Bronze
- Powder Coat
- Clad Finishes, Stainless Steel & Naval Brass
- Custom Size Available

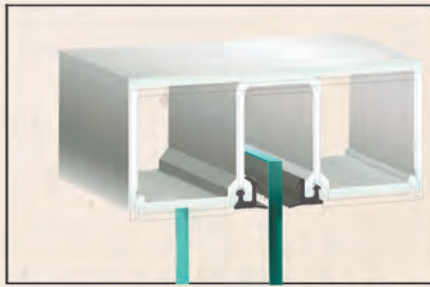

1 3/4" H X 4" W  
**PL-400SH**

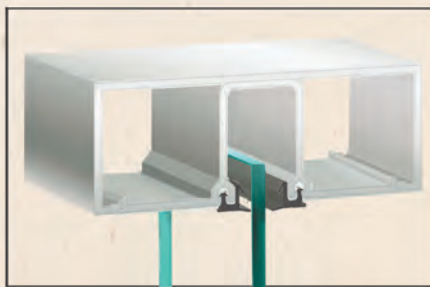

1 3/4" H X 4 1/2" W  
**PL-450SH**

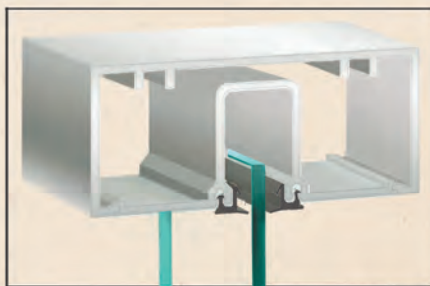

2" H X 4 1/2" W  
**PL-250SH**

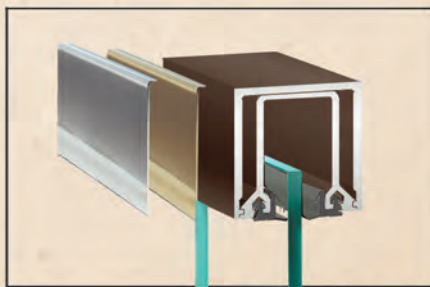

1 3/4" H X 1 3/4" W  
**PL-175SH**



BP Style Doors with 1 3/4" x 4" Continuous DS Header



Sidelite with 1 3/4" x 1 3/4" Continuous DS Header



**Total View System**

PRL Total View System takes glass to a full magnitude with absolute transparency, using Euro-Fitting hardware that provides engineered system support with minimal visual obstruction.



Custom TVS System w/Euro-A Style Doors, Transom, Fins & SL System



TVS System with Euro-A Doors & Lever Latch



**PL-450/440/414**  
TRANSOM/SL/FIN/PIVOT BRACKET  
4 1/8" H / 8 1/2" W



**PL-19102**  
LOCK PATCH FITTING  
3 1/8" H / 6 3/4" W



**PL-16500**  
LOCK PATCH FITTING  
2" H / 6 1/2" W



**PL-16300**  
LOCK PATCH FITTING  
4 1/4" H / 3" W



### LARGE

Taller Doors  
UL approved



up to  
10 ft  
High\*

### Features:

- Dummy Panic Handles
- Secure Cylinder/ Key Housing
- Door stop/Strike bracket
- Optional Door Strike Hardware Available
- Adaptable to small format IC Core cylinders
- Custom Finishes
- All Glass, Full Rail & Custom Mounting
- Standard & Custom Configurations/Exterior Handles

### STRONGER

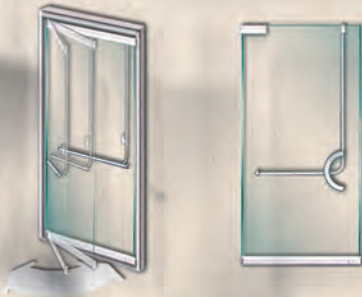

Tested to  
2.0 million cycles

Custom  
Exterior  
Pulls

### INNOVATIVE



Custom  
Square  
Bar

Round  
Bar/  
Mitered  
Corners

Panic Bar Style Options

### FASTER

- **Leadtime 3 days!\***
- **Take Advantage of Our Urgency Program**



P Style Door with PL100 Panic Device & FS Exterior Handle





A Style Doors with PL 100 Panic Device B Exterior Handle



P Style Door with PL 100 Panic Device A Exterior Handle

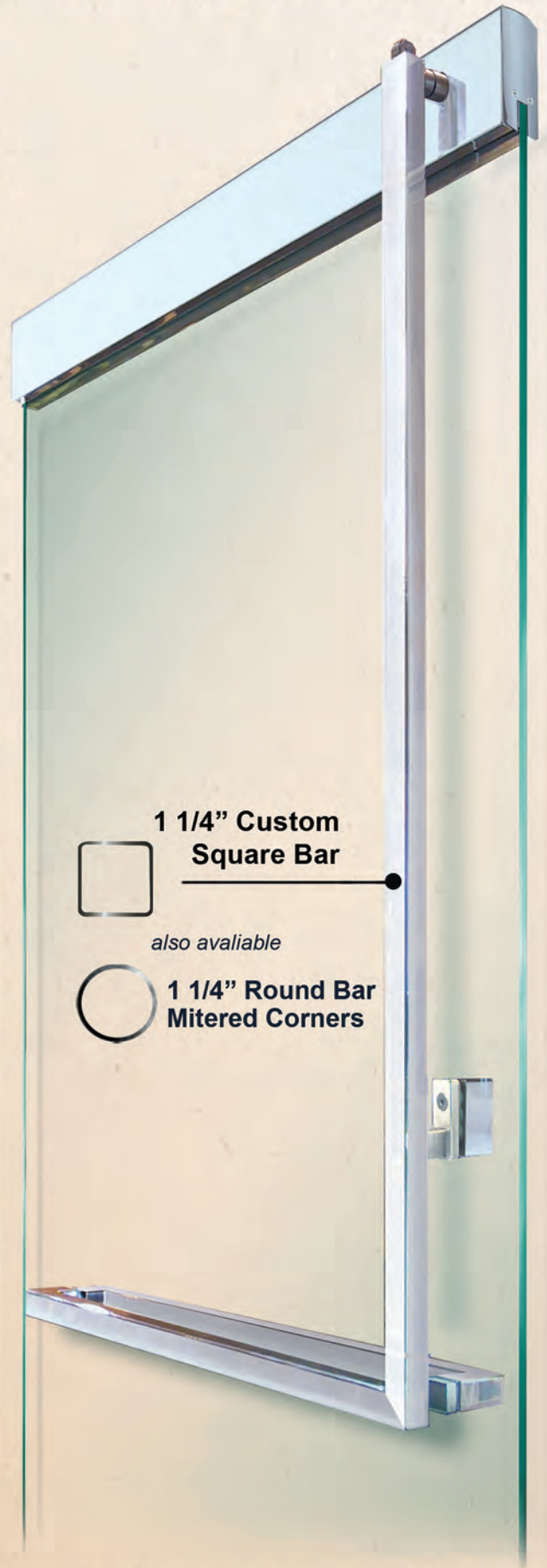

1 1/4" Custom Square Bar



also available



1 1/4" Round Bar Mitered Corners



**Deadbolt**



1 1/4" Custom Square Bar

also available  
1 1/4" Round Bar



BP Style Door/Floating Header Entry/Round Deadbolt



Full Frame/Custom Deadbolt



P Style Doors/Square Deadbolt





WS 450 Narrow Stile I-Line Doors with Full Height Deadbolt

**Deadbolt**

**Line Convenient Options:**

- Manufactured in round or square tube.
- Operable from outside with key cylinder and from inside with a convenient thumb-turn.
- Offers a locking option at the head or floor
- The pulls can be custom manufactured at any length either full or half on request.
- Deadbolts are manufactured in stainless steel.



Deadbolt mechanism at a convenient height



BP Style Doors with Deadbolt and Floating Header



PRL continues to design, manufacture and develop innovative hardware to complement our variety of door styles. Easy Lock Ladder Pulls are designed to add contemporary functionality to standard & monumental entrance doors.

- Half Length locks at head or floor
- Full Length locks at head and/or floor
- Flexible key outside and thumb-turn inside option
- Elegant custom designs
- Custom length available consult us for details



*Easy locking mechanism at a convenient height*



P Style Doors with Full Height Easy Lock Ladder Pulls



**Easy Lock Ladder Pulls**  
Custom/ Standard



Stainless Steel Clad Full Framed Door with Custom Square Easy Lock Ladder Pull with ARI Laminated Glass Compound Surface Panels

Custom Easy Lock Hexagonal



Bottom Roller Sliding Doors

Easy Lock Ladder Diamond Style



Full Frame Doors

Standard Full / Half Length



All Glass Doors

Short Ladder Pull



Tiffany Top Hung Sliding Doors



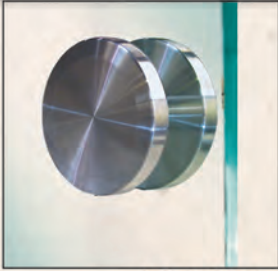

**PL-RND**  
8" DIA.



**PL-RCT**  
10"/12" CC



**PL-LPSQ**  
36"/48" - 60"/72"  
72"/84" CC/OAL

**PL-SFU**  
44"/48" - 68"/72"  
80"/84" CC/OAL



Full Frame with Custom PL-RCT Pull



**PL-VRT**  
10"/24" CC

**Custom Pulls**

PRL Custom Push/Pulls offer a significant degree of flexibility.

The metal push/pulls are available in several finishes to match or harmonize with most door styles and architectural frames



**Standard Pulls**



Custom Commercial Doors with PL-3OS Pulls



**PL-LADDER**  
36"/48"-60"/72"-72"/84" CC/OAL



**PL-3**  
10"/12"/18" CC



**PL-3 Offset**  
10"/12"/18" CC



**PL-5**  
12" CC



Custom Height P-Style Door with Full Height Ladder Pull

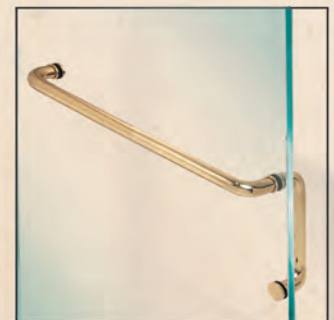

**PL-8**  
10"/28" CC



We are only a simple click away

# Quick Order, Quotes Online & Specifications Download

at **PRL Glass & Aluminum**

NAME	DESCRIPTION	SPECS
<b>SLIDERS</b>		
Tiffany Sliding Doors		<input checked="" type="checkbox"/>
Ruby Sliding Doors		<input checked="" type="checkbox"/>
Max Sliders		<input checked="" type="checkbox"/>
Accordion Bi-fold		<input checked="" type="checkbox"/>
<b>HANDRAILS</b>		
Infinity Handrail		<input checked="" type="checkbox"/>
Handrail & Guardrail		<input checked="" type="checkbox"/>
<b>STOREFRONTS</b>		
Storefronts Series 201, 250, 251, 400, 401, 450		<input checked="" type="checkbox"/>
<b>CURTAIN WALL</b>		
Aluminum Curtain Wall		<input checked="" type="checkbox"/>

**PRL** GLASS SYSTEMS  
13644 NELSON AVE.  
CITY OF INDUSTRY, CA. 91746



Shop online at [prglass.com](http://prglass.com)

videos tutorials available on how to place orders or get a quote.



Architectural Specification available online ready to use

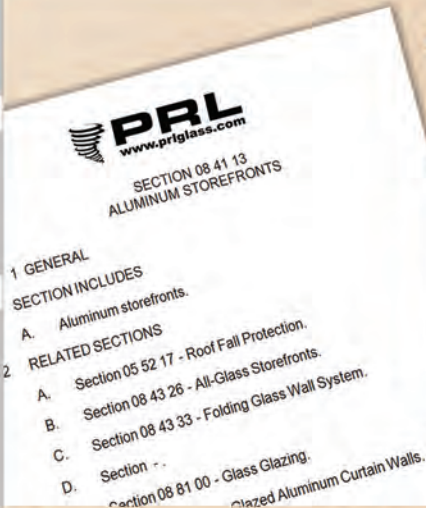

PRL Aluminum - ph. (877) 775 2586 • fx. (877) 274 8800 • 14760 Don Julian Rd. Industry, CA 91746  
PRL Glass - ph. (800) 433 7044 • fx. (626) 968 9256 • 13644 Nelson Ave. Industry, CA 91746